

# GLOBAL JOURNAL

OF RESEARCHES IN ENGINEERING: J

## General Engineering

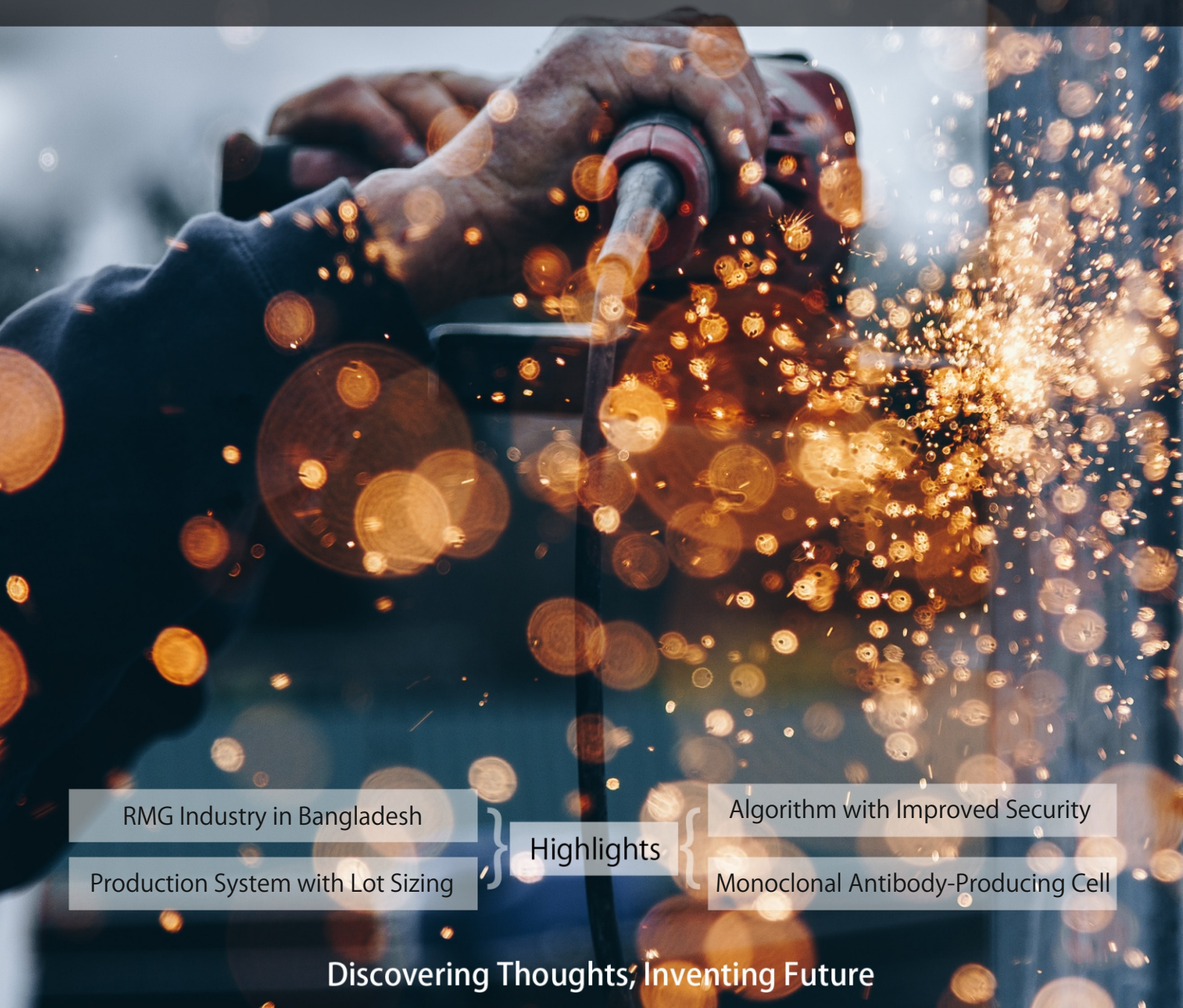

RMG Industry in Bangladesh

Production System with Lot Sizing

} Highlights {

Algorithm with Improved Security

Monoclonal Antibody-Producing Cell

**Discovering Thoughts, Inventing Future**

VOLUME 23    ISSUE 1    VERSION 1.0



GLOBAL JOURNAL OF RESEARCHES IN ENGINEERING: J  
GENERAL ENGINEERING

---



GLOBAL JOURNAL OF RESEARCHES IN ENGINEERING: J  
GENERAL ENGINEERING

---

VOLUME 23 ISSUE 1 (VER. 1.0)

OPEN ASSOCIATION OF RESEARCH SOCIETY

© Global Journal of  
Researches in Engineering.  
2023.

All rights reserved.

This is a special issue published in version 1.0  
of "Global Journal of Researches in  
Engineering." By Global Journals Inc.

All articles are open access articles distributed  
under "Global Journal of Researches in  
Engineering"

Reading License, which permits restricted use.  
Entire contents are copyright by of "Global  
Journal of Researches in Engineering" unless  
otherwise noted on specific articles.

No part of this publication may be reproduced  
or transmitted in any form or by any means,  
electronic or mechanical, including  
photocopy, recording, or any information  
storage and retrieval system, without written  
permission.

The opinions and statements made in this  
book are those of the authors concerned.  
Ultrapublishing has not verified and neither  
confirms nor denies any of the foregoing and  
no warranty or fitness is implied.

Engage with the contents herein at your own  
risk.

The use of this journal, and the terms and  
conditions for our providing information, is  
governed by our Disclaimer, Terms and  
Conditions and Privacy Policy given on our  
website [http://globaljournals.us/terms-and-condition/  
menu-id-1463/](http://globaljournals.us/terms-and-condition/menu-id-1463/).

By referring / using / reading / any type of  
association / referencing this journal, this  
signifies and you acknowledge that you have  
read them and that you accept and will be  
bound by the terms thereof.

All information, journals, this journal,  
activities undertaken, materials, services and  
our website, terms and conditions, privacy  
policy, and this journal is subject to change  
anytime without any prior notice.

Incorporation No.: 0423089  
License No.: 42125/022010/1186  
Registration No.: 430374  
Import-Export Code: 1109007027  
Employer Identification Number (EIN):  
USA Tax ID: 98-0673427

## Global Journals Inc.

(A Delaware USA Incorporation with "Good Standing"; Reg. Number: 0423089)

Sponsors: Open Association of Research Society

Open Scientific Standards

### *Publisher's Headquarters office*

Global Journals® Headquarters  
945th Concord Streets,  
Framingham Massachusetts Pin: 01701,  
United States of America

USA Toll Free: +001-888-839-7392

USA Toll Free Fax: +001-888-839-7392

### *Offset Typesetting*

Global Journals Incorporated  
2nd, Lansdowne, Lansdowne Rd., Croydon-Surrey,  
Pin: CR9 2ER, United Kingdom

### *Packaging & Continental Dispatching*

Global Journals Pvt Ltd  
E-3130 Sudama Nagar, Near Gopur Square,  
Indore, M.P., Pin:452009, India

### *Find a correspondence nodal officer near you*

To find nodal officer of your country, please  
email us at [local@globaljournals.org](mailto:local@globaljournals.org)

### *eContacts*

Press Inquiries: [press@globaljournals.org](mailto:press@globaljournals.org)

Investor Inquiries: [investors@globaljournals.org](mailto:investors@globaljournals.org)

Technical Support: [technology@globaljournals.org](mailto:technology@globaljournals.org)

Media & Releases: [media@globaljournals.org](mailto:media@globaljournals.org)

### *Pricing (Excluding Air Parcel Charges):*

Yearly Subscription (Personal & Institutional)  
250 USD (B/W) & 350 USD (Color)

# EDITORIAL BOARD

GLOBAL JOURNAL OF RESEARCH IN ENGINEERING

## *Dr. Ren-Jye Dzeng*

Professor Civil Engineering, National Chiao-Tung University, Taiwan Dean of General Affairs, Ph.D., Civil & Environmental Engineering, University of Michigan United States

## *Dr. Iman Hajirasouliha*

Ph.D. in Structural Engineering, Associate Professor, Department of Civil and Structural Engineering, University of Sheffield, United Kingdom

## *Dr. Ye Tian*

Ph.D. Electrical Engineering The Pennsylvania State University 121 Electrical, Engineering East University Park, PA 16802, United States

## *Dr. Eric M. Lui*

Ph.D., Structural Engineering, Department of Civil & Environmental Engineering, Syracuse University United States

## *Dr. Zi Chen*

Ph.D. Department of Mechanical & Aerospace Engineering, Princeton University, US Assistant Professor, Thayer School of Engineering, Dartmouth College, Hanover, United States

## *Dr. T.S. Jang*

Ph.D. Naval Architecture and Ocean Engineering, Seoul National University, Korea Director, Arctic Engineering Research Center, The Korea Ship and Offshore Research Institute, Pusan National University, South Korea

## *Dr. Ephraim Suhir*

Ph.D., Dept. of Mechanics and Mathematics, Moscow University Moscow, Russia Bell Laboratories Physical Sciences and Engineering Research Division United States

## *Dr. Pangil Choi*

Ph.D. Department of Civil, Environmental, and Construction Engineering, Texas Tech University, United States

## *Dr. Xianbo Zhao*

Ph.D. Department of Building, National University of Singapore, Singapore, Senior Lecturer, Central Queensland University, Australia

## *Dr. Zhou Yufeng*

Ph.D. Mechanical Engineering & Materials Science, Duke University, US Assistant Professor College of Engineering, Nanyang Technological University, Singapore

## *Dr. Pallav Purohit*

Ph.D. Energy Policy and Planning, Indian Institute of Technology (IIT), Delhi Research Scientist, International Institute for Applied Systems Analysis (IIASA), Austria

## *Dr. Balasubramani R*

Ph.D., (IT) in Faculty of Engg. & Tech. Professor & Head, Dept. of ISE at NMAM Institute of Technology

*Dr. Sofoklis S. Makridis*

B.Sc(Hons), M.Eng, Ph.D. Professor Department of Mechanical Engineering University of Western Macedonia, Greece

*Dr. Steffen Lehmann*

Faculty of Creative and Cultural Industries Ph.D., AA Dip University of Portsmouth United Kingdom

*Dr. Wenfang Xie*

Ph.D., Department of Electrical Engineering, Hong Kong Polytechnic University, Department of Automatic Control, Beijing University of Aeronautics and Astronautics China

*Dr. Hai-Wen Li*

Ph.D., Materials Engineering, Kyushu University, Fukuoka, Guest Professor at Aarhus University, Japan

*Dr. Saeed Chehreh Chelgani*

Ph.D. in Mineral Processing University of Western Ontario, Adjunct professor, Mining engineering and Mineral processing, University of Michigan United States

*Belen Riveiro*

Ph.D., School of Industrial Engineering, University of Vigo Spain

*Dr. Adel Al Jumaily*

Ph.D. Electrical Engineering (AI), Faculty of Engineering and IT, University of Technology, Sydney

*Dr. Maciej Gućma*

Assistant Professor, Maritime University of Szczecin Szczecin, Ph.D.. Eng. Master Mariner, Poland

*Dr. M. Meguellati*

Department of Electronics, University of Batna, Batna 05000, Algeria

*Dr. Haijian Shi*

Ph.D. Civil Engineering Structural Engineering Oakland, CA, United States

*Dr. Chao Wang*

Ph.D. in Computational Mechanics Rosharon, TX, United States

*Dr. Joaquim Carneiro*

Ph.D. in Mechanical Engineering, Faculty of Engineering, University of Porto (FEUP), University of Minho, Department of Physics Portugal

*Dr. Wei-Hsin Chen*

Ph.D., National Cheng Kung University, Department of Aeronautics, and Astronautics, Taiwan

*Dr. Bin Chen*

B.Sc., M.Sc., Ph.D., Xian Jiaotong University, China. State Key Laboratory of Multiphase Flow in Power Engineering Xi'an Jiaotong University, China

*Dr. Charles-Darwin Annan*

Ph.D., Professor Civil and Water Engineering University Laval, Canada

*Dr. Jalal Kafashan*

Mechanical Engineering Division of Mechatronics KU Leuven, Belgium

*Dr. Alex W. Dawotola*

Hydraulic Engineering Section, Delft University of Technology, Stevinweg, Delft, Netherlands

*Dr. Shun-Chung Lee*

Department of Resources Engineering, National Cheng Kung University, Taiwan

*Dr. Gordana Colovic*

B.Sc Textile Technology, M.Sc. Technical Science Ph.D. in Industrial Management. The College of Textile? Design, Technology and Management, Belgrade, Serbia

*Dr. Giacomo Risitano*

Ph.D., Industrial Engineering at University of Perugia (Italy) "Automotive Design" at Engineering Department of Messina University (Messina) Italy

*Dr. Maurizio Palesi*

Ph.D. in Computer Engineering, University of Catania, Faculty of Engineering and Architecture Italy

*Dr. Salvatore Brischetto*

Ph.D. in Aerospace Engineering, Polytechnic University of Turin and in Mechanics, Paris West University Nanterre La Defense Department of Mechanical and Aerospace Engineering, Polytechnic University of Turin, Italy

*Dr. Wesam S. Alaloul*

B.Sc., M.Sc., Ph.D. in Civil and Environmental Engineering, University Technology Petronas, Malaysia

*Dr. Ananda Kumar Palaniappan*

B.Sc., MBA, MED, Ph.D. in Civil and Environmental Engineering, Ph.D. University of Malaya, Malaysia, University of Malaya, Malaysia

*Dr. Hugo Silva*

Associate Professor, University of Minho, Department of Civil Engineering, Ph.D., Civil Engineering, University of Minho Portugal

*Dr. Fausto Gallucci*

Associate Professor, Chemical Process Intensification (SPI), Faculty of Chemical Engineering and Chemistry Assistant Editor, International J. Hydrogen Energy, Netherlands

*Dr. Philip T Moore*

Ph.D., Graduate Master Supervisor School of Information Science and engineering Lanzhou University China

*Dr. Cesar M. A. Vasques*

Ph.D., Mechanical Engineering, Department of Mechanical Engineering, School of Engineering, Polytechnic of Porto Porto, Portugal

*Dr. Jun Wang*

Ph.D. in Architecture, University of Hong Kong, China Urban Studies City University of Hong Kong, China

*Dr. Stefano Invernizzi*

Ph.D. in Structural Engineering Technical University of Turin, Department of Structural, Geotechnical and Building Engineering, Italy

*Dr. Togay Ozbakkaloglu*

B.Sc. in Civil Engineering, Ph.D. in Structural Engineering, University of Ottawa, Canada Senior Lecturer University of Adelaide, Australia

*Dr. Zhen Yuan*

B.E., Ph.D. in Mechanical Engineering University of Sciences and Technology of China, China Professor, Faculty of Health Sciences, University of Macau, China

*Dr. Jui-Sheng Chou*

Ph.D. University of Texas at Austin, U.S.A. Department of Civil and Construction Engineering National Taiwan University of Science and Technology (Taiwan Tech)

*Dr. Houfa Shen*

Ph.D. Manufacturing Engineering, Mechanical Engineering, Structural Engineering, Department of Mechanical Engineering, Tsinghua University, China

*Prof. (LU), (UoS) Dr. Miklas Scholz*

Cand Ing, BEng (equiv), PgC, MSc, Ph.D., CWEM, CEnv, CSci, CEng, FHEA, FIEMA, FCIWEM, FICE, Fellow of IWA, VINNOVA Fellow, Marie Curie Senior, Fellow, Chair in Civil Engineering (UoS) Wetland Systems, Sustainable Drainage, and Water Quality

*Dr. Yudong Zhang*

B.S., M.S., Ph.D. Signal and Information Processing, Southeast University Professor School of Information Science and Technology at Nanjing Normal University, China

*Dr. Minghua He*

Department of Civil Engineering Tsinghua University Beijing, 100084, China

*Dr. Philip G. Moscoso*

Technology and Operations Management IESE Business School, University of Navarra Ph.D. in Industrial Engineering and Management, ETH Zurich M.Sc. in Chemical Engineering, ETH Zurich, Spain

*Dr. Stefano Mariani*

Associate Professor, Structural Mechanics, Department of Civil and Environmental Engineering, Ph.D., in Structural Engineering Polytechnic University of Milan Italy

*Dr. Ciprian Lapusan*

Ph. D in Mechanical Engineering Technical University of Cluj-Napoca Cluj-Napoca (Romania)

*Dr. Francesco Tornabene*

Ph.D. in Structural Mechanics, University of Bologna Professor Department of Civil, Chemical, Environmental and Materials Engineering University of Bologna, Italy

*Dr. Kitipong Jaojaruek*

B. Eng, M. Eng, D. Eng (Energy Technology, Asian Institute of Technology). Kasetsart University Kamphaeng Saen (KPS) Campus Energy Research Laboratory of Mechanical Engineering

*Dr. Burcin Becerik-Gerber*

University of Southern California Ph.D. in Civil Engineering Ddes, from Harvard University M.S. from University of California, Berkeley M.S. from Istanbul, Technical University

*Hiroshi Sekimoto*

Professor Emeritus Tokyo Institute of Technology Japan Ph.D., University of California Berkeley

*Dr. Shaoping Xiao*

BS, MS Ph.D. Mechanical Engineering, Northwestern University The University of Iowa, Department of Mechanical and Industrial Engineering Center for Computer-Aided Design

*Dr. A. Stegou-Sagia*

Ph.D., Mechanical Engineering, Environmental Engineering School of Mechanical Engineering, National Technical University of Athens, Greece

*Diego Gonzalez-Aguilera*

Ph.D. Dep. Cartographic and Land Engineering, University of Salamanca, Avilla, Spain

*Dr. Maria Daniela*

Ph.D in Aerospace Science and Technologies Second University of Naples, Research Fellow University of Naples Federico II, Italy



*Dr. Omid Gohardani*

Ph.D. Senior Aerospace/Mechanical/ Aeronautical,  
Engineering professional M.Sc. Mechanical Engineering,  
M.Sc. Aeronautical Engineering B.Sc. Vehicle  
Engineering Orange County, California, US

*Dr. Paolo Veronesi*

Ph.D., Materials Engineering, Institute of Electronics,  
Italy President of the master Degree in Materials  
Engineering Dept. of Engineering, Italy

## CONTENTS OF THE ISSUE

---

- i. Copyright Notice
- ii. Editorial Board Members
- iii. Chief Author and Dean
- iv. Contents of the Issue
  
1. Optimization of Total Cost of Production for a Mixed Make-To-Order (MTO) and Make-To-Stock (MTS) Production System with Lot Sizing for the RMG Industry in Bangladesh. *1-20*
2. Determination of Best Nutritional Conditions for a Monoclonal Antibody-Producing Cell Line based on a Multivariate Data Analysis Approach. *21-31*
3. New Encryption Algorithm with Improved Security. *33-40*
  
- v. Fellows
- vi. Auxiliary Memberships
- vii. Preferred Author Guidelines
- viii. Index



GLOBAL JOURNAL OF RESEARCHES IN ENGINEERING: J  
GENERAL ENGINEERING  
Volume 23 Issue 1 Version 1.0 Year 2023  
Type: Double Blind Peer Reviewed International Research Journal  
Publisher: Global Journals  
Online ISSN: 2249-4596 & Print ISSN: 0975-5861

## Optimization of Total Cost of Production for a Mixed Make-To-Order (MTO) and Make-To-Stock (MTS) Production System with Lot Sizing for the RMG Industry in Bangladesh

By Md. Imran Hosen, Jaglul Hoque Mridha, Masum Musfiq,  
Md. Shahin Hossen, Mohammed Raihan Uddin, Md. Sakib-Uz-Zaman,  
Shoaib Mahmud & Arif Hossain

*Primeasia University*

**Abstract-** This paper contains a production and inventory planning model with lot sizing in an RMG factory. This model is an example of mixed integer linear programming. The primary goal of this approach, which combines the make-to-order (MTO) and make-to-stock (MTS) production methods are to simultaneously satisfy existing customer orders and new customer orders in order to reduce the total cost. Here, make-to-order (MTO) and make-to-stock (MTS) production systems are becoming more and more common since they allow businesses to increase revenues while managing expenses by maintaining a positive cash flow. For mixed contexts where demand is cyclical but predictable, and the model stores the predicted data and fresh forthcoming orders.

**Keywords:** *inventory, productivity, turnover, lingo, MTO, knitwear, production cost.*

**GJRE-J Classification:** *DDC Code: 338.456760973 LCC Code: HD9826*



*Strictly as per the compliance and regulations of:*



© 2023. Md. Imran Hosen, Jaglul Hoque Mridha, Masum Musfiq, Md. Shahin Hossen, Mohammed Raihan Uddin, Md. Sakib-Uz-Zaman, Shoaib Mahmud & Arif Hossain. This research/review article is distributed under the terms of the Attribution-NonCommercial-NoDerivatives 4.0 International (CC BY-NC-ND 4.0). You must give appropriate credit to authors and reference this article if parts of the article are reproduced in any manner. Applicable licensing terms are at <https://creativecommons.org/licenses/by-nc-nd/4.0/>.

# Optimization of Total Cost of Production for a Mixed Make-To-Order (MTO) and Make-To-Stock (MTS) Production System with Lot Sizing for the RMG Industry in Bangladesh

Md. Imran Hosen <sup>α</sup>, Jaglul Hoque Mridha <sup>σ</sup>, Masum Musfiq <sup>ρ</sup>, Md. Shahin Hossen <sup>ω</sup>,  
Mohammed Raihan Uddin <sup>¥</sup>, Md. Sakib-Uz-Zaman <sup>§</sup>, Shoab Mahmud <sup>x</sup> & Arif Hossain <sup>v</sup>

**Abstract-** This paper contains a production and inventory planning model with lot sizing in an RMG factory. This model is an example of mixed integer linear programming. The primary goal of this approach, which combines the make-to-order (MTO) and make-to-stock (MTS) production methods are to simultaneously satisfy existing customer orders and new customer orders in order to reduce the total cost. Here, make-to-order (MTO) and make-to-stock (MTS) production systems are becoming more and more common since they allow businesses to increase revenues while managing expenses by maintaining a positive cash flow. For mixed contexts where demand is cyclical but predictable, and the model stores the predicted data and fresh forthcoming orders. For the simulation, creation of the model, and output, data were gathered from Samad Sweaters Ltd. The concept is relevant to numerous production sectors, including the textile, apparel, steel, and food sectors. As its main objective is to reduce costs through lot sizing, industries that adopt this strategy can boost their profit margins while also keeping costs down. Additionally, it determines the cost of ordering and acquiring the raw materials. Another strategy for reducing risk and raising revenue is to subcontract the order. This is an alternative model option for completing an order by the delivery date.

**Keywords:** *inventory, productivity, turnover, lingo, MTO, knitwear, production cost.*

**Author α:** Lecturer (Industrial & Production Engineering), Department of Textile Engineering, Primeasia University, Bangladesh. e-mail: imran.butex12@gmail.com

**Author σ:** Assistant Professor, Department of Textile Engineering, International Standard University, Bangladesh. e-mail: jaglul.mridha92@gmail.com

**Author ρ:** Senior Executive- Planning, Epyllion Limited, Epyllion group, Bangladesh. e-mail: masummusfiq.ipe@gmail.com

**Author ω:** Executive- Planning, Epyllion Limited, Epyllion group, Bangladesh. e-mail: shahin.butex42@gmail.com

**Author ¥:** Assistant Merchandiser, Lindex, Bangladesh. e-mail: rai.onekhan@gmail.com

**Author §:** Lecturer, Department of Textile Engineering, Primeasia University, Bangladesh. e-mail: sakibzaman2018@gmail.com

**Author x:** Ahsanullah University of Science & Technology, Bangladesh. e-mail: shoaibmahmud94@gmail.com

**Author v:** Ahsanullah University of Science & Technology, Bangladesh. e-mail: arifhossainrakib77@gmail.com

## I. INTRODUCTION

In the modern period resources are in higher demand today because of rising global economic and demographic trends. Additionally, the COVID-19 and Russia-Ukraine war widen the global imbalance between supply and demand (Zakeri et al., 2022). As a result, the manufacturing sector is confronting significant difficulties due to rising costs for raw materials, energy, and logistics. This has led to a decline in consumer satisfaction and an increase in product pricing. It is known that the ready-made clothing (RMG) industry in Bangladesh has been one of the primary drivers of the country's economy (Mridha et al., 2022). Our RMG industry is mainly buyer oriented. So, customer satisfaction with low cost of the product is the major concern. As demand and supply gap is increasing day by day so resource optimization is now one of the major concerns to reduce the cost of production. So, this is why manufacturing companies now employ a variety of production policies to improve customer satisfaction and optimization of resources. There are several distinct production strategies, including make-to-stock (MTS) (Karabağ & Gökgür, 2022), make-to-order (MTO) (Smith, 2020), assemble-to-order (ATO) (Micieta et al., 2021), and mixed MTO & MTS. MTO (make to order) is a production strategy that starts manufacturing only after a customer's order is received. When a need is genuinely present, an assembly process begins, or manufacturing begins with development planning. Make to stock (MTS) is a traditional production strategy that is used in many industries to match production and inventory with customer demand forecasts. This method requires an accurate forecast of demand in order to determine how much stock should be produced. Each has pros and cons.

Production planning covers a variety of production-related topics, including suppliers, raw materials, quality control, lot sizing, transportation, and a host of others. For example, inventory costs, ordering costs, fixed costs, profit margins, break-even point costs, and many more are costs that are taken into

account during manufacturing. Just-in-time (JIT), Materials Requirements Planning (MRP), Vendor Management Inventory (VMI), and Distribution Resource Planning are examples of inventory control techniques (DRP). Three different order size models are available for replenishing inventory: the quantity discount model, economic production quantity, and basic economic order quantity (EOQ) (Rafiqh et al., 2022). However, the most crucial step is the one that decides whether an operation will be profitable or not. MTS and MTO have mostly been used in production planning sectors among these policies. Consider the cost of manufacturing as well as lot sizing as the process increases production flexibility.

#### a) *Objective of the Study*

The main objective of this research is to develop a proper mixed MTO & MTS method which will have unique steps to solve the problems which the industries have been facing. This mixed model will reduce inventory levels, turnover and improve equipment utilization.

## II. LITERATURE REVIEW

MTO (make to order) is a production strategy which starts manufacturing only after a customer's order is received. When a need is genuinely present, an assembly process begins, or manufacturing begins with development planning. Other times, the production process begins with the acquisition of materials and parts, or even further back from development designing. In some circumstances, the process of assembling prepared pieces begins when actual demand develops (engineering). This system is actually conducted based on customer orders, leading to higher flexibility, low storage cost and long delivery times as the major features of these systems. As production is not done until a customer order is received. So this strategy eliminates finished- goods inventories and reduces a firm's exposure falling into financial risk. It usually requires long customer lead-times and large order backlogs.

Make to stock (MTS) is a traditional production strategy that is used in many industries to match production and inventory with customer demand forecasts. This method requires an accurate forecast of demand in order to determine how much stock should be produced. If demand for the product can properly be forecasted, the MTS strategy is an efficient choice for production. In the MTS systems, normally finished products are made and stocked upon the forecasted data according to customer demands and customers receive their products from nearby warehouses. Therefore, the main drawback to the MTS method of production is the inaccurate forecasts that will lead to losses, stemming from excess inventory or stock out.

Mixed MTS and MTO production system is one of the most unique strategies which have recently been attracted by the academicians and practitioners. In the past few years, companies have changed their production strategies towards hybrid MTS/MTO environments to achieve the advantages of both pure MTS and pure MTO systems simultaneously. In this regard, many studies have been done on the performance and control of these MTS–MTO systems combining pure MTS and MTO systems in a sequential manner to produce standard semi-finished modules and stock them as an unfinished/semi-finished inventory at the MTS stage (first step) and assign various finished products to order according to specific requirements through customization at the MTO stage. This is actually a Hybrid MTO & MTS system which is very versatile and many problems can be solved through this which was not possible before. It does both the work of MTO & MTS in the same time and it is very unique. Combination of MTO and MTS is the basis for advanced production management.

Lot sizing is a very crucial factor in this model. It mainly determines the quantity of an item which is ordered for delivery on a specific date or manufactured in a single production run. It can also be defined by the total quantity of a product ordered for producing or manufacturing. In a manufacturing industry or company, the raw materials are to be ordered from a supplier and the suppliers do not deliver the raw materials below their required lot size or quantity level with a price tag. So, choosing the proper lot sizing can be very much beneficial for an industry or any manufacturing company for optimizing the total cost. Nowadays it is being done in the newly developed industries or companies.

A heuristic framework with master production scheduling (MPS) was developed for an apparel factory in 2001. The target was to minimize the total cost whether the demands were completed before or after their due dates. (Najhan et al., 2016) The operations management research characterizes the production system as either make-to-order (MTO) or make-to-stock (MTS). The MTO systems offered a high variety of customer specific and typically, more expensive products. Capacity planning, order acceptance/rejection, and attaining high due-date adherence were the main operations issues. A proposal was made for a comprehensive hierarchical planning framework that covered the important production management decisions to serve as a starting point for evaluation. (Soman et al., 2004).

A hierarchical production planning structure for combined MTS/MTO was established in 2006. They developed the model of four phases. C A Soman, Van Donk, & Gaalman enforced the implementation of a production planning and scheduling framework for a medium sized multi product food processing in 2007. As a consequence of huge increases in product variety and

shorter lead time requirements of customers, the company was forced to shift a part of its production system from make to stock to make to order and had to operate under a Hybrid MTO and MTS strategy. (Noorwali, 2014) The MTO orders might be so low that a substantial amount of capacity became idle. This may lead to a higher production cost and result in undesirable loss in financial statements because semiconductor manufacturing was very capital-intensive. Some foundries might include the production of make-to-stock (MTS) products to increase capacity utilization. A proposal of scheduling method for such a hybrid MTO/MTS system with machine-dedication characteristics and constraint imposed on the process route caused by the advance of manufacturing technology. (Wu et al., 2008)

The customers can be grouped in market segments having specific characteristics, especially concerning the demand variety and the required customer lead-time. The end-products can be split in two classes: few products with high volume demands and a large number of products with low-volume demands. In order to reduce inventory costs, it seemed efficient to produce the high-volume products according to an MTS policy and the low volume products according to an MTO policy. Two policies were considered: the classical FIFO policy and a priority policy (PR), which gave priority to low volume products over high-volume products. (Youssef et al., 2017) Businesses competed on response time focused on producing a limited portfolio of products. Delaying product differentiation is a hybrid strategy that strives to reconcile the dual needs of high variety and quick response time. A common product platform was built to stock in the first stage of production, which was then differentiated into different products after demand was known in the second stage that referred make to stock and make to order. Delaying differentiation carried several benefits. Maintaining stocks of semi-finished goods reduced the order-fulfillment delay relative to the pure MTO system. Since many different end products had common parts, holding semi-finished goods inventory benefits from demand pooling, which was known to lower the amount of inventory needed to achieve a service-level performance equal to a comparable system with no pooling. (Gupta & Benjaafar, 2010)

Most applicable production policies are Make-To-Stock (MTS), Make-To-Order (MTO), Assemble-To-Order (ATO) and Engineer-To-Order (ETO) production policies can be used to satisfy customer's demands. Each policy had some specific advantages and disadvantages. Among them, MTS and MTO systems have been widely used in the production companies. In MTS companies, the customer's demands were satisfied with stocked inventories of finished products. The dominant features of such systems were shorter

delivery time, heavy storage cost and low flexibility in responding to customized needs of customers (Kalantari et al., 2011). The production planning research had not been paying the necessary attention to the complexities of production systems of such items in 2011. Inventory control retailers acknowledged that papers discussing production scheduling of perishable goods were relatively rare, and papers discussing simultaneous lot sizing and scheduling were even rarer. Still, perishability was in several cases a very important issue concerning the tactical and operational level of production planning. (Amorim et al., 2011) Günalay developed production policies in 2011 inventory cost took a large portion of total manufacturing cost. For the maximum efficiency, both production and inventory systems should be considered at the same time. There was some conflicting objective faced by the Supplier. Suppliers created a variety of products to serve both large and small customer orders with unreliable demand information. They also faced customer pressure to improve quality, lower cost and reduce delivery delay. These conflicting objectives forced the use of both MTO and MTS strategies. There two production policies (MTO and MTS) were implied along with two scheduling strategies (FIFO VS CYCLIC). (Günalay, 2011)

Comparison and analysis of order fulfillment performance measures for two different production control systems: make-to-order versus make-to-stock in 2012. The formulated service maximization was modeled with inventory cost budget constraints to determine the right base-stock level for each component in the make-to-order (MTO) system and for the final product in the make-to-stock (MTS) system and identified the key driving factors. (Shao & Dong, 2012) Aslan, Stevenson, & Hendry revealed a case study on the ERP (Enterprise Resource Planning) selection process by a MTO company and concluded that more research was required to assist firms in determining the applicability of ERP in 2014. Make-To-Stock (MTS) producers might have a significant bearing on its internal decision-making processes and therefore, on any functionality it requires from an ERP system. Enterprise Resource Planning (ERP) system was investigated through a mixed method approach consisting of an exploratory and explanatory survey followed by three case studies. Data on Make-To-Stock (MTS) companies was also collected as a basis for comparison. (Aslan et al., 2014)

MTO and MTS systems could be used in many fields such as apparel and confection companies and also semiconductor factories. MTO/MTS hybrid system combines both policies which can be switched between both operations flexibly. A flexible service rule with demand prioritization and pricing rules were proposed. The operating cost and the MTO queue length were evaluated by Markov analysis.

(Kanda et al., 2015) Adan & Van Der Wal worked with lesser and lesser production systems organized in (MTS). A lot of research concerned the performance and control of these systems (multi-echelon inventory control). No product was made without a client. The analysis of these systems called for the queuing model. For production planning and inventory control, one was tempted to use one of two strategies: produce all demand to stock or produce all demand to order. In the 'make everything to order' case (MTO) the response times might become quite long if the load was high, in the 'make everything to stock' case (MTS) one got an enormous inventory if the number of different products was large. (Adan & Van Der Wal, n.d.)

There was a formulation of a nonlinear integer programming model for accurate planning, delivery and product quality for steel industries in 2015. For external market and internal manufacturing requirements, high equipment utilization and low production cost was needed for the comparative market policy. Order planning was a very important matter as for the bulky machines and high operating cost. The order planning played a vital role in the performance of the steel industry. The process referred to a mixed integer nonlinear programming model to solve the ordering plan with the combination of MTS/MTO. This concept referred to order planning and inventory matching of both finished and unfinished products. It exerted multiple objectives such as earliness/tardiness penalty, production cost, inventory matching cost, order cancelation penalty. It also offered an improved particle Swarm optimization (PSO) method. (Zhang et al., 2015)

Inventory is an important issue to fulfill customer's demand. Efficient inventory control improved its competitiveness. Inventory management control methods included Just In Time (JIT), Materials Requirement Planning (MRP), Vendor Management Inventory (VMI), and Distribution Resource Planning (DRP). In inventory there were three types of order size models including the basic economic order quantity (EOQ), economic production quantity (EPQ), and quantity discount model. (Najhan et al., 2016) The main features of MTS systems are high storage cost, shorter delivery time and low responsiveness to customer orders. On the other hand, MTO systems are conducted based on customer orders, leading to low storage cost, high flexibility and long delivery times. A method based on discrete event simulation was used to simulate the process of order receiving, raw materials warehousing and production in the kitchen of a five-star restaurant in Tehran. According to the important parameters of the result, with the geographical conditions and public interests in traditional foods, the increase of restaurant salon capacity had higher priority and could lead to increased net profit. (Rabbani & Dolatkah, 2017) A model in order to reduce overall inventory costs and an efficient approach to produce some items according to

a make-to-stock (MTS) policy and others according to a make-to-order (MTO) policy was established in 2017. Items priority levels played a key role in the optimal MTO/MTS decisions for such typical large-scale systems. To tackle this issue, the manufacturing facility was modeled as a multiproduct multi priority classic queuing system. A general optimization procedure was proposed that selected near-optimal priority classes, gave the associated flow control mode (MTO or MTS) for each product and provided a lower bound and an upper bound with respect to the optimal cost. (Youssef et al., 2017)

Textiles and clothing are the most dynamic products in world trade. Textile manufacturing systems involved more than one stage with each stage yielding a product that was either pulled as finished product or further reprocessed in the next stage. A different production planning method might be used for each production stage. Here hierarchical production planning could be taken. A hierarchical production planning and scheduling model encompassing an apparel production planning system. It presented a decision support system dealing with the production planning and scheduling in the textile industry. (Kotayet et al., n.d.) Product-mix scheduling problems are needed to minimize setup operations while keeping a due date and queuing time restrictions of every production WIP (work-in-process) and thus to maximize the OEE (Overall Equipment Effectiveness) of the machines while keeping a shorter lead time of the WIP. When a loading or a capacity of Fab were dynamically changing, the objective was that maximization of the resource utilization while keeping a due date and queuing time restrictions of every production lot. (Owner, n.d.)

Customer satisfaction played a key role in the competitive market and had been the most important reason to change managers' points of view. Some important strategy of production planning was discussed. Most particularly, the strategic level of Hybrid Make-To-Stock (MTS)/Make-To-Order (MTO) production contexts used Fuzzy Analytic Network Process. It emphasized the aggregate planning with ordering of products and to maintain the stock. (Rafiei & Rabbani, 2014)

There were several works which were done with either MTO or MTS. But for an individual, there were some disadvantages faced by the process such as long customer lead Times, large order backlogs and proper level of inventory etc. A mixed MTO and MTS model can reduce those disadvantages by considering each other's advantages. This mixed model will reduce inventory level, increase turnover, reduce lead time, and improve equipment utilization.

### III. METHODS

Aggregate production planning is a marketing strategy that creates an aggregate plan for the

production process 6-18 months in advance to give management an idea of how much material and other resources will be produced and when they will be produced. So that the total cost of operations for the organization is kept to a minimum over that period. In aggregate production planning, many criteria are included. This section discusses the extent to which outsourcing and subcontracting are used. Labor overtime, the number of laborers to be hired and fired in each period, and the amount of inventory to be held in stock and backlogged for each period are all decided. All of these activities are done within the framework of the company's ethics, policies, and long-term commitment to the society, community, and country of operation.

Aggregate planning has certain pre-required inputs which are inevitable. They involve-

1. Information about the resources and the facilities available.
2. Demand forecast for the period for which the planning has to be done and when to be done.
3. The Cost of several alternatives and resources. This contains the cost of holding inventory, ordering cost, cost of production through various production alternatives like subcontracting, backordering and overtime cost.
4. The organizational policies regarding the usage of above alternatives.

"This planning is actually done by matching supply and demand of output over the medium time range, up to approximately 12 months into the future. The term aggregate determines that the planning is done for a single overall measure of output or, at the most, a few aggregated product categories. The aim of aggregate planning is to set overall output levels in the near to medium future in the face of fluctuating or uncertain demands. Aggregate planning may seek to influence demand as well as supply. The make to order (MTO) and make to stock (MTS) are important parts of this aggregate planning section.

Mixed MTO & MTS is a unique production system which is programmed as MILP and considered for evaluating this problem. It is an integer programming model for mathematical optimization or feasibility program in which some or all of the variables are restricted to be integers. In many settings the term refers to be Integer Linear Programming (ILP) in which the Objective function and constraints (other than the integer constraints) are linear. A mixed integer programming (MIP) problem can contain both integer and continuous variables. If the problem contains an objective function with no quadratic term (a linear objective), then the problem is termed as a Mixed Integer Linear Programming (MILP). However, if a quadratic term in the objective function is contained, the

problem is termed as a Mixed Integer Quadratic Programming (MIQP).

Not only many important applications can be naturally modeled as MIQP but a variety of more general MINLP can be reformulated by this class of problems. Particularly MIQP comprises two widely studied classes of optimization problems:

- Mixed-integer linear programming. (MILP)
- Quadratic programming. (QP)

The process refers to the mixed integer linear Programming (MILP) using Lingo 18.0 for the required problems. The problem was with supplier, inventory cost, raw materials and scheduling. This model can be implemented in different kinds of industries like steel industries, garments factories and food industries. For this model industry will be able to reduce the production cost efficiently. There are some data which have been taken from Samad sweaters LTD for the simulation and formation of the model and getting output from it.

In this model the mixed integer linear programming being used as the result formulated by lingo 18.0. The process will also consider the lot sizing process for the optimization for the cost of production. The model will help to decide for choosing the appropriate lot sizing model. This model is composed of a mixed make to order (MTO) and make to stock (MTS) process which is a unique idea for the industries who want to optimize their cost. Another important subject is lot sizing which is considered in this model. The proposed model has been formulated and discussed with necessary parameters and diagrams.

#### a) Model Formation

This statement is carried out in the working procedure: This system combines the make to order (MTO) and make to stock (MTS) processes in the same plant for fulfilling the market demand and new customers' orders at the same time while optimizing their total cost. By using this model, when and how much product needs to be produced at the regular time and overtime production can be known. It also defines the amount of raw material that needs to be purchased and how much should be sent to subcontract along with maintaining the inventory level. The amount of raw material bought from the supplier is dependent on the ordering cost per unit and lead time. If the ordering cost is higher, then ordering the raw materials for multiple orders at the same time will be a suitable option as it reduces the cost. Another important part of this model is the Subcontract portion. It is only applicable for the MTO products. The planning section determines the quantity of products if transferred to the subcontract portion is enough to deliver the final products on time. If the total cost line increases, then the model will calculate and transfer some portion to the subcontract to reduce the costs. A Flow Process of Mixed MTO & MTS Process is shown below in Figure 1:





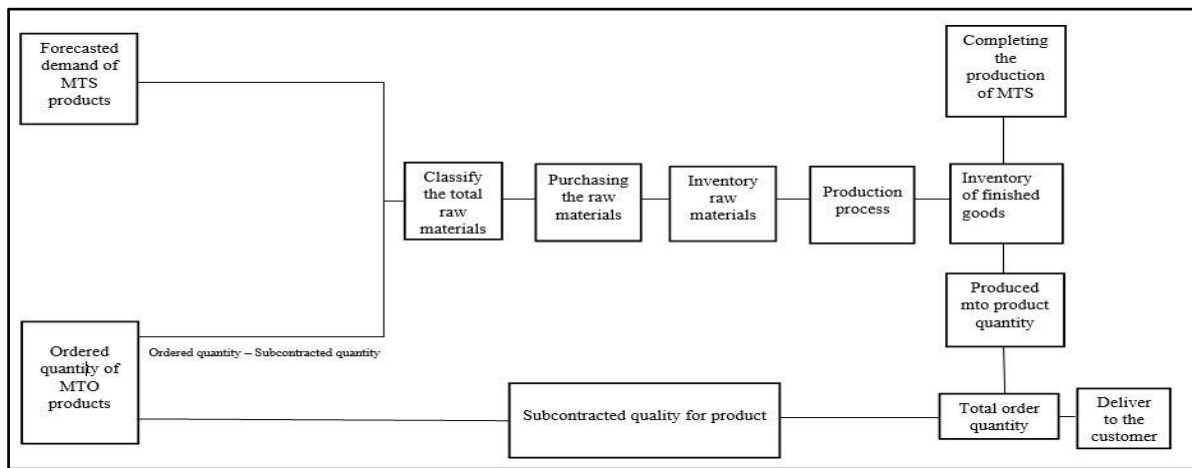

Figure 1: Flow Process of Mixed MTO & MTS Process

b) Assumptions

1. Raw materials arrived at a promising time.
2. Overtime is allowed for MTO and MTS production.
3. The production capacity is known and fixed.
4. Subcontracting is allowed for MTO products only.
5. Production cost includes labor cost and maintenance cost.
6. There is no minimum batch size required for subcontracted products.
7. MTS production must be completed before the delivery date in order to supply them to the market.
8. When a new order is placed, a new planning horizon starts.
9. MTO products are to be delivered on the exact date.
10. There is no Shortage cost available.

c) Working Procedure

The following steps have been followed throughout the model-

d) Index Sets

Sets	Index
T: set of time periods	t
I: set of made to order (MTO) products	i
J: set of made to stock (MTS) products	j
R: set of fabric types	r

1. At the beginning of the planning horizon depending on the forecasted data (for a time period), calculating the ordering price and raw material purchasing price the planning section also classifies and plans when and how much raw material is required depending on the quantity of the product they are producing for the production.
2. Then it is planned how much raw material should be needed for any certain week and the required amount of raw material is ordered from the suppliers. The amount of raw material bought from the supplier is dependent on the ordering cost per unit and lead time.
3. After that, the required raw material is bought and brought in the inventory section considering the lead time before one week of the production starts.
4. If any raw material fails to come within the given time for the exceeding lead time, then there will be no production on that week and the production of that week will be switched to the next week.

e) *Input Parameters*

<b>Input Parameters</b>		
$V_i^O$	Storage space required per unit of finished MTO product i	$m^3$
$IC_i^O$	Inventory cost of final MTO product i	USD
$V_j^S$	Storage space required per unit of finished MTS product j	$m^3$
$IC_j^S$	Inventory cost of MTS product, j	USD
$V_r$	Storage space required of per unit of finished raw material, r	$m^3$
$ICR_r$	Inventory cost of raw material r	USD
$RPC_i^O$	Regular time production cost for MTO product i	USD
$OPC_i^O$	Overtime production cost of MTO product i during period t	USD
$RPC_j^S$	Regular time product cost for MTS product j	USD
$OPC_j^S$	Overtime production cost of MTS product j during period t	USD
$SCO_i$	Subcontracting cost for MTO product i	USD
$RP_r$	Purchasing price of raw material r	USD
$OC_r$	Ordering cost of raw material r	USD
$AR_{ri}^O$	Amount of raw material r required for MTO product i	UNIT
$AR_{rj}^S$	Amount of raw material r required for MTS product j	UNIT
$WRMAX$	Maximum inventory level of raw material	$m^3$
$PP_i^O$	Working hour required to produce per unit MTO product i	Minute/product
$PP_j^S$	Working hour required produced per unit MTS product j	Minute/product
$ARWMAX_t$	Available regular maximum working hour at period t	Minute
$AOWMAX_t$	Available maximum overtime working hour at period t	minute
$RQD_{it}^O$	Required to deliver the finished MTO product i at period t	UNIT
$BD_{it}^O$	Binary int variables, for subcontract delivery MTO products i during period t. $BD_{it}^O = 0$ for product that is not delivered and $BD_{it}^O = 1$ for product delivery	
$BS_i^O$	Binary integer variables, for allowing subcontract for MTO products. $BS_i^O = 0$ for no subcontract and $BS_i^O = 1$ otherwise	
$FD_{jt}$	Forecasted demand of product j during period of t	UNIT
$IILF_{j0}^S$	Initial Inventory level of MTS product j	UNIT
$ILFPMAX$	Maximum inventory level of final product	$m^3$
$BP_{it}^O$	Binary integer variables, $BP_{it}^O = 1$ for MTO product m is produced in period t, $BP_{it}^O = 0$ otherwise	
$CO_i$	Confirmed order quantity for MTO product i	UNIT
$M$	Large number	
$OQMAX_r$	Maximum order capacity for raw material r	UNIT
$OQMIN_r$	Minimum order quantity for raw material r	UNIT
$B_i^O$	Minimum batch size production for MTO products i	UNIT
$B_j^S$	Minimum batch size production for MTS products j	UNIT
$PL$	Number of production line	UNIT

Decision Variables		
$ILF_{it}^0$	Inventory level of Final MTO product, i	UNIT
$ILF_{jt}^S$	Inventory level of Final MTS product, j	UNIT
$IR_{rt}$	Inventory level of raw material r during period t	UNIT
$RQ_{it}^0$	Regular time production quantity of MTO product i during period t	UNIT
$OQ_{it}^0$	Overtime production quantity of MTO product i during period t	UNIT
$RQ_{jt}^S$	Regular time production quantity of MTS product j during period t	UNIT
$OQ_{jt}^S$	Overtime production quantity of MTS product j during period t	UNIT
$SQ_i$	Subcontracting amount of product i	UNIT
$RQB_{rt}$	Raw material r bought at the period of t	UNIT
$RQR_{rt}$	Raw material r required at the period of t	UNIT
$ILFP_t$	Inventory level of final products at during period t	m <sup>3</sup>
$Z_{it}^0$	Binary integer variable, $Z_{it}^0 = 1$ ; for MTO product i at the period of t will be produced, $Z_{it}^0 = 0$ otherwise	
$Z_{jt}^S$	Binary integer variable, $Z_{jt}^S = 1$ ; for MTS product j at the period of t will be produced, $Z_{jt}^S = 0$ otherwise	
$Y_{rt}$	Binary integer variable, $Y_{rt} = 1$ ; for raw material r purchased at the period of t, $Y_{rt} = 0$ otherwise.	

f) *The Objective Function*

The objective function aims at optimizing the total cost of an industry by optimizing the inventory cost, production cost, subcontracting cost and purchasing cost. The subcontracting cost is a cost on which an industry decides whether they will subcontract their product or not depending on the cost optimization. If delivering an order under some constraints is required to fulfill a demand under subcontract, then it is done or vice versa.

g) *Model Equation*

Inventory Cost =  $\sum_i \sum_t ILF_{it}^0 * V_i^0 * IC_i^0 + \sum_j \sum_t ILF_{jt}^S * V_j^S * IC_j^S + \sum_r \sum_t IR_{rt} * V_r * ICR_r$   
 Production Cost: =  $\sum_i \sum_t RQ_{it}^0 * RPC_i^0 + \sum_i \sum_t OQ_{it}^0 * OPC_i^0 + \sum_j \sum_t RQ_{jt}^S * RPC_j^S + \sum_j \sum_t OQ_{jt}^S * OPC_j^S$   
 Subcontracting Cost:  $\sum_i SQ_i * SCO_i$   
 Purchasing Cost:  $\sum_r \sum_t RQB_{rt} * RP_r + \sum_r \sum_t Y_{rt} * OC_r$   
 MIN = Inventory Cost + Production Cost + Subcontracting cost + Purchasing cost  
 Subject to;

1.  $\sum_i (RQ_{it}^0 + OQ_{it}^0) * AR_{it}^0 + \sum_j (RQ_{jt}^S + OQ_{jt}^S) * AR_{jt}^S = RQR_{rt}; \forall r, \forall t;$
2.  $RQB_{rt} + IR_{r(t-1)} - RQR_{rt} = IR_{rt}; \forall r, \forall t;$
3.  $\sum_r IR_{rt} * V_r \leq WRMAX; \forall t;$
4.  $\sum_i RQ_{it}^0 * PP_i^0 + \sum_j RQ_{jt}^S * PP_j^S \leq ARWMAX * PL; \forall t;$
5.  $\sum_i OQ_{it}^0 * PP_i^0 + \sum_j OQ_{jt}^S * PP_j^S \leq AOWMAX * PL; \forall t;$
6.  $ILF_{i(t-1)}^0 + RQ_{it}^0 + OQ_{it}^0 - RQD_{it}^0 + SQ_i * BD_{it}^0 * BS_i^0 = ILF_{it}^0; \forall i, \forall t;$
7.  $ILF_{j(t-1)}^S + RQ_{jt}^S + OQ_{jt}^S - FD_{j(t+1)} = ILF_{jt}^S; \forall j, \forall t;$
8.  $ILF_{j0}^S - FD_{j1} = ILF_{j0}^S; \forall j$
9.  $\sum_i ILF_{it}^0 * V_i^0 + \sum_j ILF_{jt}^S * V_j^S = ILFP_t; \forall t;$
10.  $ILFP_t \leq ILFPMAX; \forall t;$
11.  $\sum_t (RQ_{it}^0 + OQ_{it}^0) * BP_{it}^0 + SQ_i * BS_i^0 = CO_i;$
12.  $RQB_{rt} \leq \sum_{t=t}^T RQR_{rt}; \forall r, \forall t;$
13.  $RQB_{rt} \leq M * Y_{rt}; \forall r, \forall t$
14.  $RQB_{rt} \leq OQMAX_r; \forall r, \forall t;$
15.  $RQB_{rt} \geq OQMIN_r; \forall r, \forall t;$
16.  $RQ_{it}^0 + OQ_{it}^0 \geq B_i^0 * Z_{it}^0; \forall i, \forall t$
17.  $Z_{it}^0 \geq \frac{1}{M} * \sum_i (RQ_{it}^0 + OQ_{it}^0); \forall i, \forall t;$
18.  $RQ_{jt}^S + OQ_{jt}^S \geq B_j^S * Z_{jt}^S; \forall j, \forall t;$
19.  $Z_{jt}^S \geq \frac{1}{M} * \sum_j (RQ_{jt}^S + OQ_{jt}^S); \forall j, \forall t;$
20.  $Y_{rt} \in \{0,1\}; \forall r, \forall t;$
21.  $Z_{it}^0 \in \{0,1\}; \forall i, \forall t;$
22.  $Z_{jt}^S \in \{0,1\}; \forall j, \forall t;$

The regular and overtime production of MTO and MTS by constraint (1) indicates the amount of raw material required for a certain period of time and (2) indicates what amount raw material is bought for inventory level. Equation (3) defines the maximum raw material inventory as constraints and (4) and (5) denotes the maximum available working hour capacity for regular and overtime products respectively. And (6) denotes the inventory level of finished MTO products. Equation ((7) indicates forecasted demands for MTS products and (8) indicates the inventory balance equation at the beginning of the planning horizon after fulfilling the first week forecasted demand from the finished goods inventory. The (9) satisfies the inventory level of the finished goods products and (10) defines the capacity constraints for the inventory level of final products. (11) Indicates the MTO order quantity for satisfactory constraints. Equation (12) and (13) determines the required purchasing raw material as it's a balance equation. The (14) & (15) implies the boundary level of the raw material purchasing quantity. The equation (16) & (17) satisfies the base size of production for MTO production and equation (18) & (19) presents the minimum batch production quantity of MTS products. The (20) (21) & (22) acts as a binary variable.

#### IV. DATA ANALYSIS

There are many industries in our country in which either make to order (MTO) or make to stock (MTS) are done in order to manufacture products. This problem mainly occurs when the demand is so high and the delivery time is short. Nowadays, with increasing population, the demand is uncertain, and there needs a new model to solve this problem by optimizing the total cost. So, this optimized make to order and make to stock model can be applied to solve this problem as this model can be applied to any industry that follows only one of the above-mentioned processes. This model optimizes the total cost along with proper lot sizing. If any industry follows this model, they can optimize their total cost and fulfill the customer's demand. For continuing the both processes, we found a garment in which only make to order (MTO) is followed. But they get the order of the same product after 3-4 years which can be manufactured in make to stock (MTS). So, if they start doing make to stock along with make to order they can fulfill the entire demand. So, this model can be practically implemented and there are some data which has been taken from Samad sweaters LTD for the simulation and formation of the model and getting output from it.

##### a) Data Outputs

##### i. Mixed MTO & MTS Production Process

*Table 1:* Inventory level Raw Materials for Mixed MTO & MTS Production process

Time (Week)	1	2	3	4	5	6	7	8
Yarn (acrylic)	380.932	370.932	0	659.5	0	330.5	0	0
Zipper (6inch)	380.932	370.932	0	1649.5	990	330.5	0	0
Button	17217	17157	14931.4	9897	5940	1983	0	0
Accessories	2869.5	2859.5	2488.57	1649.5	990	330.5	0	0
Yarn (nylon)	531.827	267.027	146.6	146.6	141.6	136.6	0	0
Button	8509.23	4272.43	2345.6	2345.6	2265.6	2185.6	0	0
Accessories	1063.65	534.054	293.2	293.2	283.2	273.2	0	0

*Table 2:* Raw material required for Mixed MTO & MTS Production process

Time (Week)	1	2	3	4	5	6	7	8
Yarn (acrylic)	330.5	10	370.932	839.068	659.5	659.5	330.5	0
Zipper (6inch)	330.5	10	370.932	839.068	659.5	659.5	330.5	0
Button	1983	60	2225.59	5034.41	3957	3957	1983	0
Accessories	330.5	10	370.932	839.068	659.5	659.5	330.5	0
Yarn (nylon)	136.6	264.8	120.427	0	5	5	136.6	0
Button	2185.6	4236.8	1926.83	0	80	80	2185.6	0
Accessories	273.2	529.6	240.854	0	10	10	273.2	0

Table 3: Raw material purchased for Mixed MTO & MTS Production process

Time (Week)	1	2	3	4	5	6	7	8
Yarn (acrylic)	711.432	0	0	1498.57	0	990	0	0
Zipper (6inch)	711.432	0	0	2488.57	0	0	0	0
Button	19200	0	0	0	0	0	0	0
Accessories	3200	0	0	0	0	0	0	0
Yarn (nylon)	668.427	0	0	0	0	0	0	0
Button	10694.8	0	0	0	0	0	0	0
Accessories	1336.85	0	0	0	0	0	0	0

Table 4: Production quantity for Mixed MTO & MTS Production process

Time (Week)		1	2	3	4	5	6	7	8
Heavy knit wear (Red)	Regular time	330.5	10	10	0	659.5	659.5	330.5	0
	Over time	0	0	0	0	0	0	0	0
Sweater (Orange)	Regular time	273.2	529.6	240.85	0	10	10	273.2	0
	Over time	0	0	0	0	0	0	0	0
Heavy knit wear (Black)	Regular time	0	0	360.93	672	0	0	0	0
	Over time	0	0	0	167.06	0	0	0	0

Table 5: Production cost for Mixed MTO & MTS Production process

Time (Week)		1	2	3	4	5	6	7	8
Heavy knit wear (Red)	Regular time	727.1	22	22	0	1450.9	1450.9	727.1	0
	Over time	0	0	0	0	0	0	0	0
Sweater (Orange)	Regular time	751.3	1456.4	662.34	0	27.5	27.5	751.3	0
	Over time	0	0	0	0	0	0	0	0
Heavy knit wear (Black)	Regular time	0	0	794.05	1478.4	0	0	0	0
	Over time	0	0	0	417.66	0	0	0	0

Table 6: Inventory Cost of final product for Mixed MTO & MTS Production process

Time (Week)	1	2	3	4	5	6	7	8
Heavy knit wear (Red)	0.661	0.681	0.701	0.701	2.02	3.339	4	0
Sweater (Orange)	0.262	0.77068	1.00190	1.00190	1.01150	1.02110	0	0
Heavy knit wear (Black)	0	0	18.0466	0	0	0	0	0

Table 7: Inventory Cost of Raw material for Mixed MTO & MTS Production process

Time (Week)	1	2	3	4	5	6	7	8
Yarn (acrylic)	1.904	1.8546	0	3.2975	0	1.6525	0	0
Zipper (6inch)	0.57	0.5563	0	2.4742	1.485	0.49575	0	0
Button	0.172	0.1715	0.1493	0.0989	0.0594	0.01983	0	0
Accessories	0.028	0.0285	0.0248	0.0164	0.0099	0.00330	0	0
Yarn (nylon)	1.595	0.8010	0.4398	0.4398	0.4248	0.4098	0	0
Button	0.085	0.0427	0.0234	0.0234	0.02265	0.02185	0	0
Accessories	0.010	0.0053	0.0029	0.0029	0.00283	0.00273	0	0

*Table 8:* Raw material purchasing cost for Mixed MTO & MTS Production process

Time (Week)	1	2	3	4	5	6	7	8
Yarn (acrylic)	1422.86	0	0	2997.13	0	1980	0	0
Zipper (6inch)	469.54	0	0	1642.45	0	0	0	0
Button	1536	0	0	0	0	0	0	0
Accessories	1056	0	0	0	0	0	0	0
Yarn (nylon)	2005.28	0	0	0	0	0	0	0
Button	1818.12	0	0	0	0	0	0	0
Accessories	1898.33	0	0	0	0	0	0	0

*Table 9:* Subcontracting Quantity for Mixed MTO & MTS Production process

subcontract for Heavy knit wear (Red)	0
subcontract for Sweater (Orange)	163.15

*Table 10:* Subcontracting cost for Mixed MTO & MTS Production process

subcontract for Heavy knit wear (Red)	0
subcontract for Sweater (Orange)	1182.838

ii. MTO Production Process

*Table 11:* Production cost for MTO Production process

Time (Week)		1	2	3	4	5	6	7	8
Heavy knit wear (Red)	Regular time	1441.5	22	22	22	0	1450.9	1441.5	0
	Over time	0	0	0	0	0	0	0	0
Sweater (Orange)	Regular time	36.85	1456.4	1456.4	1120.35	0	27.5	27.5	0
	Over time	0	0	0	0	0	0	0	0
Heavy knit wear (Black)	Regular time	0	0	0	0	0	0	0	0
	Over time	0	0	0	0	0	0	0	0

*Table 4.12:* Inventory Cost of final product for MTO Production process

Time (Week)	1	2	3	4	5	6	7	8
Heavy knit wear (Red)	1.3305	1.3505	1.3705	1.371	2.689	4	0	0
Sweater (Orange)	0.5212	1.0297	1.4208	1.421	1.430	0	0	0
Heavy knit wear (Black)	0	0	0	0	0	0	0	0

*Table 13:* Raw material purchasing cost for MTO Production process

Time (Week)	1	2	3	4	5	6	7	8
Yarn (acrylic)	1370.5	0	0	0	0	2629.5	0	0
Zipper (6inch)	452.265	0	0	0	0	867.735	0	0
Button	960	0	0	0	0	0	0	0
Accessories	660	0	0	0	0	0	0	0
Yarn (nylon)	2250	0	0	0	0	0	0	0
Button	2040	0	0	0	0	0	0	0
Accessories	2130	0	0	0	0	0	0	0

Table 14: Inventory Cost of Raw material for MTO Production process

Time (Week)	1	2	3	4	5	6	7	8
Yarn (acrylic)	0.15	0.1	0.05	0	0	3.2762	0	0
Zipper (6inch)	0.045	0.03	0.015	0	0	0.9828	0	0
Button	0.0806	0.08009	0.0794	0.078	0.0788	0.0393	0	0
Accessories	0.0134	0.01335	0.0132	0.013	0.0131	0.0065	0	0
Yarn (nylon)	2.2299	1.4355	0.6411	0.03	0.03	0.015	0	0
Button	0.1189	0.07656	0.0341	0.001	0.0016	0.0008	0	0
Accessories	0.0148	0.00957	0.0042	0.000	0.0002	0.0001	0	0

Table 15: Subcontracting cost for MTO Production process

Subcontract for Heavy knit wear (Red)	0
Subcontract for Sweater (Orange)	0

iii. MTS Production Process

Table 16: Production cost for MTS Process

Time (Week)		1	2	3	4	5	6	7	8
Heavy knit wear (Red)	Regular time	0	0	0	0	0	0	0	0
	Over time	0	0	0	0	0	0	0	0
Sweater (Orange)	Regular time	0	0	0	0	0	0	0	0
	Over time	0	0	0	0	0	0	0	0
Heavy knit wear (Black)	Regular time	0	0	880	1478.4	0	0	0	0
	Over time	0	0	0	281.6	0	0	0	0

Table 17: Inventory Cost of final product for MTS Process

Time (Week)	1	2	3	4	5	6	7	8
Heavy knit wear (Red)	0	0	0	0	0	0	0	0
Sweater (Orange)	0	0	0	0	0	0	0	0
Heavy knit wear (Black)	0	0	0	0	0	0	0	0

Table 18: Raw material purchasing cost

Time (Week)	1	2	3	4	5	6	7	8
Yarn (Acrylic)	0	0	2400	0	0	0	0	0
Zipper (6inch)	0	0	792	0	0	0	0	0
Button	0	0	576	0	0	0	0	0
Accessories	0	0	396	0	0	0	0	0
Yarn (nylon)	0	0	0	0	0	0	0	0
Button	0	0	0	0	0	0	0	0
Accessories	0	0	0	0	0	0	0	0

Table 19: Inventory Cost of Raw material

Time (Week)	1	2	3	4	5	6	7	8
Yarn (acrylic)	0	0	4	0	0	0	0	0
Zipper (6inch)	0	0	1.2	0	0	0	0	0
Button	0	0	0.048	0	0	0	0	0
Accessories	0	0	0.008	0	0	0	0	0
Yarn (nylon)	0	0	0	0	0	0	0	0
Button	0	0	0	0	0	0	0	0
Accessories	0	0	0	0	0	0	0	0

Table 20: Subcontracting cost

subcontract for Heavy knit wear (Red)	0
subcontract for Sweater (Orange)	0

Table 21: Comparison between the total cost and Production processes

Production process	Mixed MTO & MTS Process	MTO process	MTS Process	MTO and MTS Sum cost
Inventory cost	54.65166	29.06159	25.25600	54.31759
Production cost	10766.47	8525.000	2678.400	11203.4
Raw material purchasing cost	16890.74	13418.00	4189.000	17607
Subcontracting cost	1182.807	0	0	0
Total Cost	28894.66866	21972.0616	6892.656	28864.71759

Table 22: Comparison between Inventory Cost for Mixed MTO & MTS Production process and MTO Production Process

Time (Week)	1	2	3	4	5	6	7	8
Mixed MTO & MTS	0.92327	1.45168	1.70290	1.70290	3.03150	4.36010	4	0
MTO	1.85178	2.3802	2.7913	2.7913	4.1199	4	0	0

## V. RESULTS AND DISCUSSIONS

By considering decision variables and input variables, the below graphs have been mentioned to analyze the optimization of the model to be exerted. To solve this model, Lingo 18 is used. The data collected from Samad group has been implemented in Lingo code. And the result found from the code is 28894.7

USD, the total production cost. The representation of the graphical expressions by analyzing output data with respect to time has been given below. In those data, comparison of MTO and MTS and Mixed MTO & MTS has shown respectively. The graphical expression shows the optimization of the model.

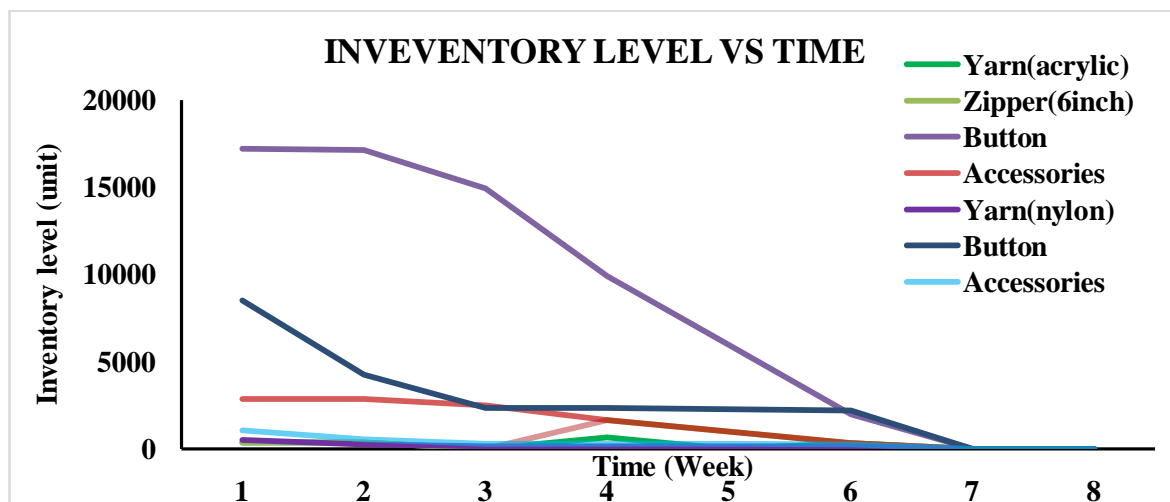

Figure 2: Inventory level of raw material VS Planning Time (Mixed MTO & MTS Process)

Figure 2 actually shows the inventory level of raw material from time to time over the time period. We can clearly see that buttons in the inventory are 17217 units in the first week which is much more than the other raw materials at that week. The second highest is

another type of buttons which are 8509.23 units. After that, accessories are 2869.5 units and the second type of accessories are 1063.65 units available in the inventory at the first week. Yarn (nylon) is available at 531.827 and yarn (acrylic) is 380.932 along with a zipper



(6 inch) in the inventory for the first week. In the third week the inventory for both of the product's yarn (acrylic) and zipper (6 inch) is zero. Then it is again

replenished from the fourth week. From the graph it is also clear that at the seventh and eighth week the inventory is totally zero for all the materials.

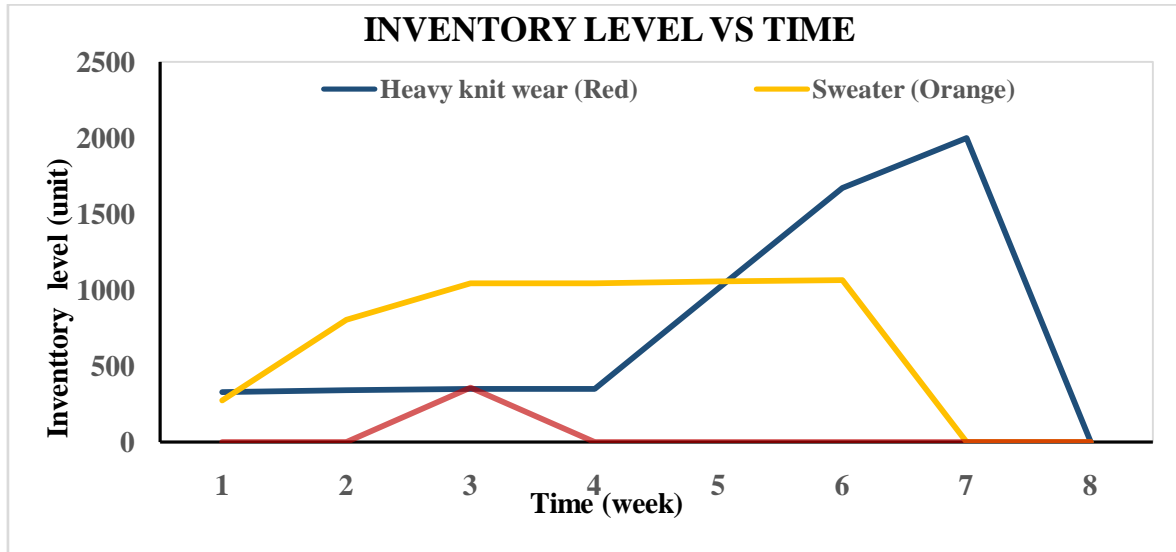

Figure 3: Inventory level of Finished Products VS Planning Time (Mixed MTO & MTS Process)

From the graph in Figure 3, we can clearly see the fluctuating demand of these products according to time versus inventory level. When the demand is higher, the required raw material is brought into inventory so that products can be produced according to demand. There are three types of products: Heavy knit wear (Black), heavy knit wear (Red) and sweater. Inventory level shows the demand in the period of time span and how much should be produced. The inventory level of

heavy knit wear (Red) is 330.5 units in the first week and it is much more than the other two. The inventory of sweaters (Orange) is 273.3 units in the first week and it becomes zero in the seventh week. The inventory level of heavy knit wear (Black) at the first and second week is zero and 360.932 units at the third week. Inventory for all the three finished products becomes zero at the eighth week.

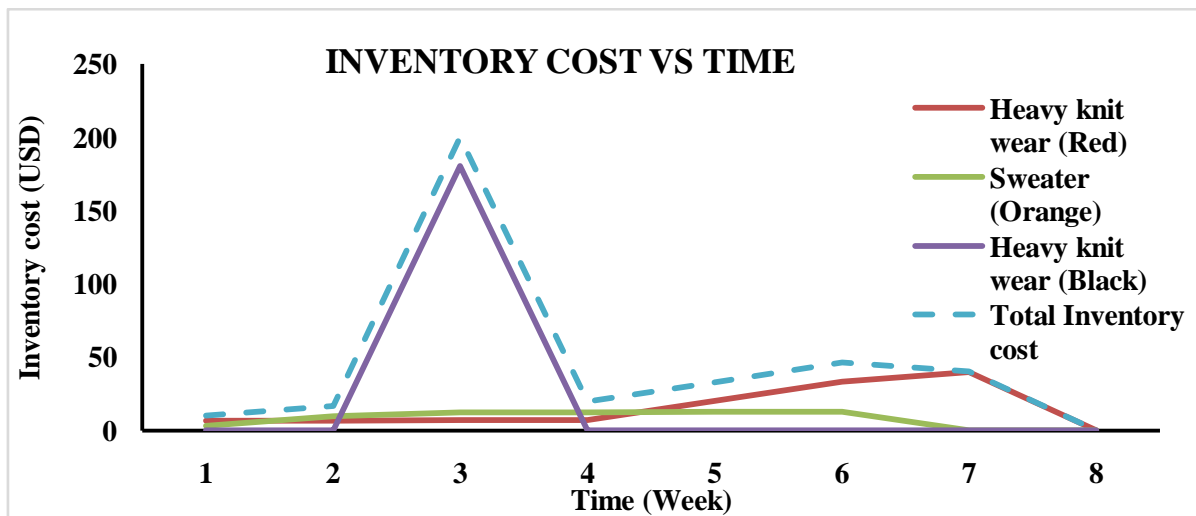

Figure 4: Inventory Cost of Finished Products VS Time (Mixed MTO & MTS Process)

From the graph in Figure 4, it is seen that the inventory cost of heavy knit wear (Red) is higher, which is 0.661 units in the first week and 0.701 for the third and fourth week respectively, than the other two of the products. The inventory cost of Sweater (Orange) is .26227 and .77068 in the first and second week

respectively. The inventory cost of heavy knit wear (Black) at the first and second week is zero unit but it is 18.0466 units at the third week of the mixed MTO & MTS process. The inventory cost of black colored neat wear is higher than the red colored knit wear. In the eight week all the inventories become zero units.

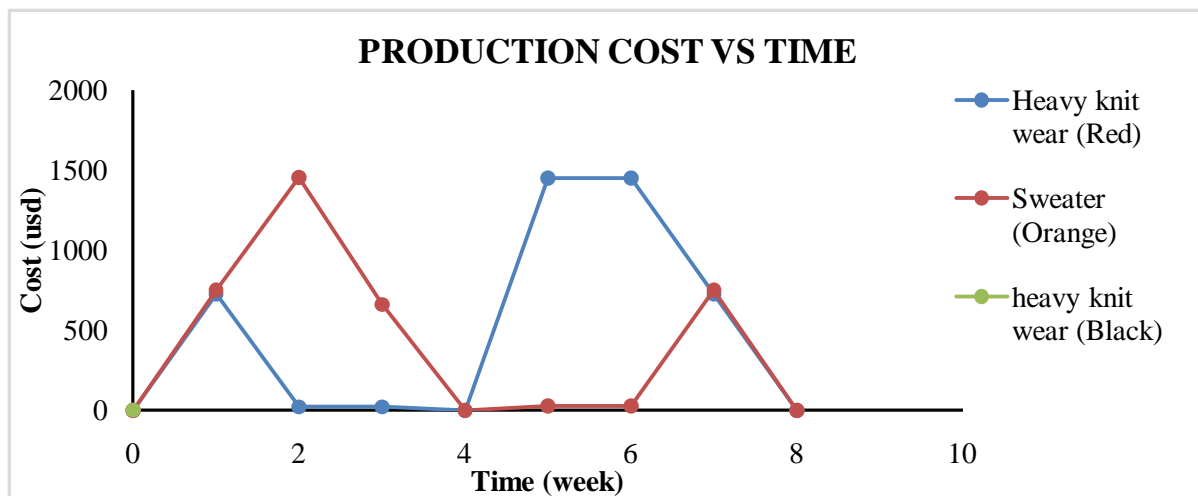

Figure 5: Production Cost of Finished Products VS Time (Mixed MTO & MTS Process)

In Figure 5, it is seen that the production cost of Sweater (Orange) is higher in the second week than the other two which is 1456.4 units and 662.349 in the third week. And it is increasing from the first week and decreasing at the fourth week. Again, the Heavy knit wear follows the same trend from fourth to eighth week and ends up at the eighth week. The cost of Heavy knit wear (Red) is 727.1 units in the first week and 22 units in

the second and third week respectively which decreases than the first week. But the cost of the Sweater (Orange) line is horizontal from fourth to sixth week and the value is 27.5 units for regular time and zero units for overtime. The cost of Heavy knit wear (Black) is 794.051 units and 1478.4 units in the third and fourth week respectively. At the eight week the cost for all the products is zero unit.

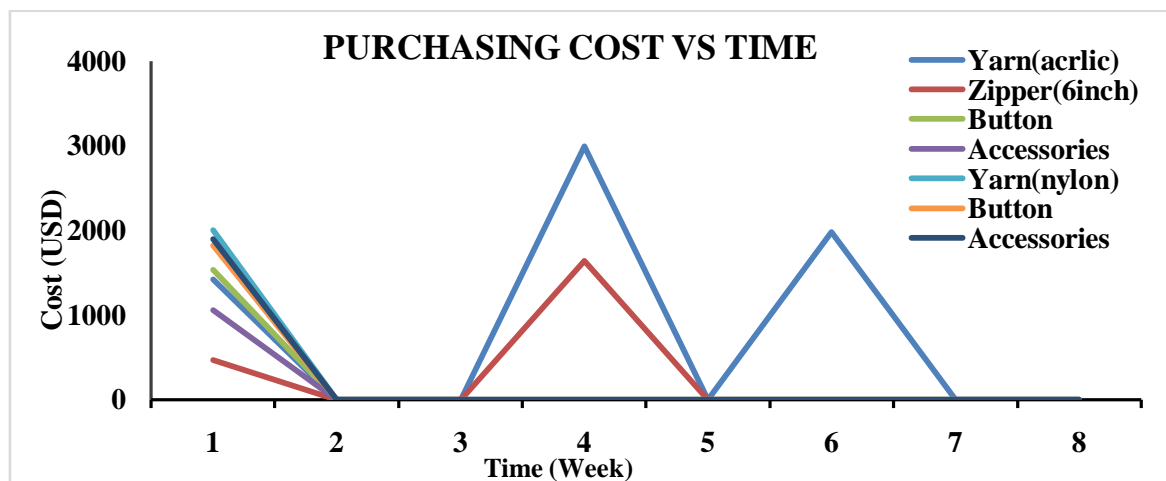

Figure 6: Purchasing Cost VS Time for Mixed MTO and MTS production Process

Figure 6 shows that the purchasing cost of all the raw materials vary from material to material. The raw material is bought in the first week and stored. The purchasing costs of Yarn (acrylic), zipper (6 inch), button first type, accessories first type, yarn (nylon), button second type and accessories second type are 1422.865, 469.545, 1536, 1056, 2005.281, 1818.121 and 1898.333 units respectively. The purchasing costs of yarn (acrylic) and zipper (6 inch) are 2997.136 and 1642.455 units in the third and fourth week which are higher than all of the other materials. At the sixth week the purchasing cost of yarn (acrylic) is 1980 units and

the others are zero. At the eight-week purchasing cost of all the materials is zero.

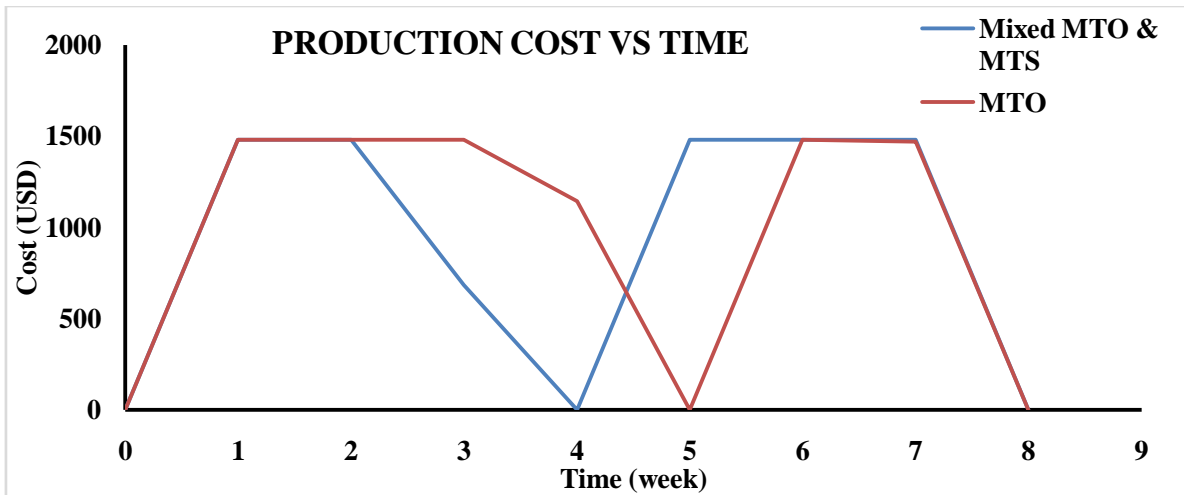

Figure 7: Comparison between Productions cost VS Time for Mixed MTO & MTS Production process and MTO Production Process

Figure 7 determines the comparison between the costs. It is clearly seen that the production cost of the MTO production process starts decreasing after the third week and the cost of the mixed MTO & MTS system decreases from the second week. The mixed cost again goes up from the fourth week and stays horizontal to time before the eighth week. The production cost of Heavy knit wear (Red) is 727.1 units

and Sweater (Orange) is 751.3 units in the first week. The production cost of Sweater (Orange) is 1456.4 units which is greater than Heavy knit wear (Red). For Heavy knit wear (Red) at the fifth and sixth week the production cost is 1450.9 respectively. And the production cost of Heavy knit wear (Black) is zero units for the first to third week and 417.6 units for the fourth week. At the eighth week the production cost for all the products is zero.

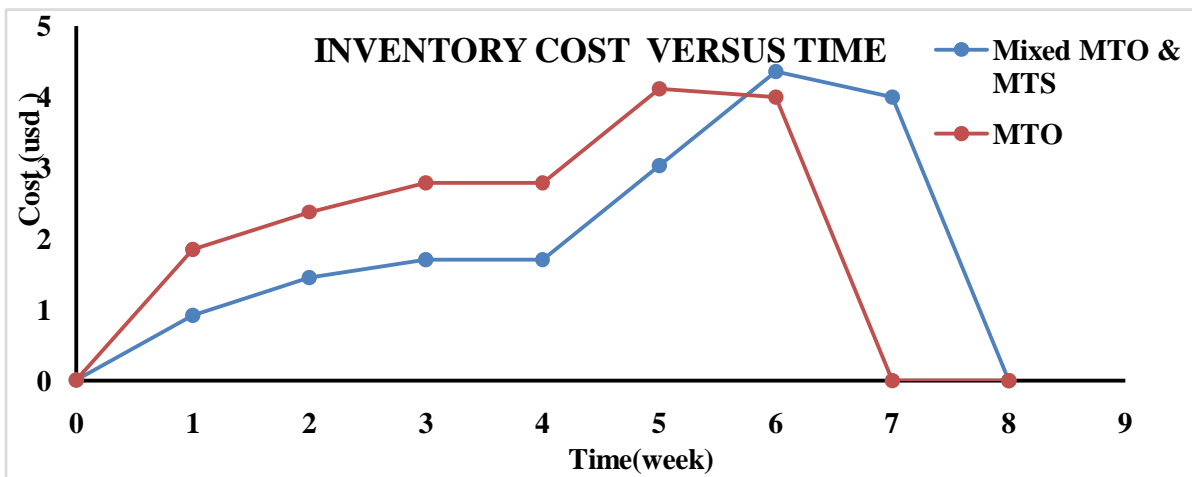

Figure 8: Comparison between Inventory Cost VS Time between Mixed MTO & MTS production Process and MTO Production Process

Figure 8 shows the comparison of inventory cost between mixed systems and MTO systems. It is clearly seen that the inventory cost of mixed MTO & MTS systems is less than the MTO till the fifth week but at the sixth week it becomes higher. From the table it is seen that the inventory cost for Sweater (Orange) is .26227 and .770688 units at the first and second week and 1.00190 units for the third and fourth week. The inventory cost of Heavy knit wear (Red) is higher till second week which is .661 and .681 units. But it starts

decreasing from the third week and the value is .701 units. Again, it increases in the fifth week which is 2.02 units. In the eighth week the inventory cost for the mixed production system is zero and at the seventh week the inventory cost for the MTO production system becomes zero.

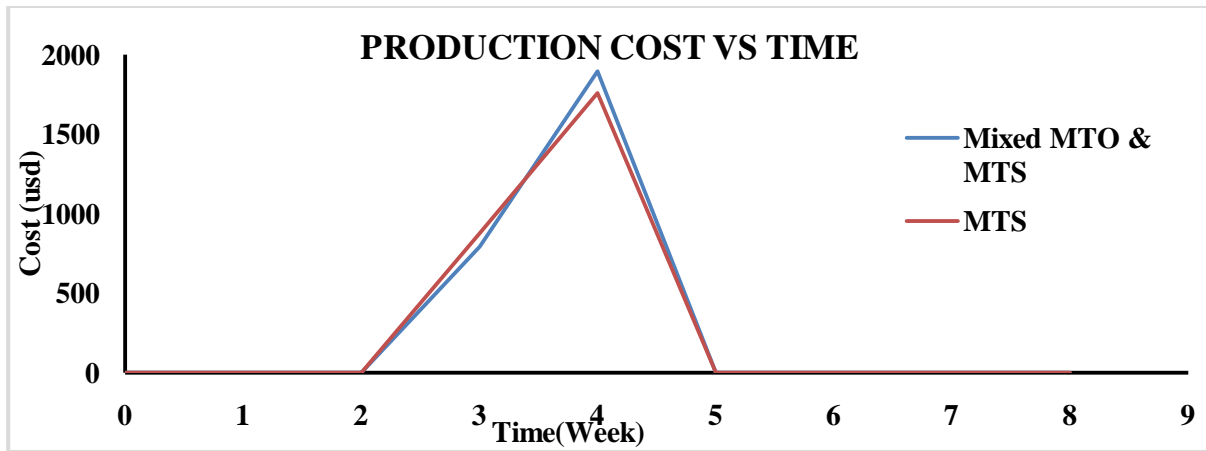

Figure 9: Comparison between Production Cost VS Time between Mixed MTO & MTS production Process and MTS Production Process

Figure 9 clearly shows that the production cost of MTS systems is less than the mixed MTO & MTS systems. And the products need to be delivered at the fifth week because a new order will be ordered at the

beginning of the fifth week. The production cost of mixed MTO & MTS is 1900 and something and the production cost of MTO is 1800 at the fifth week which is less than the other.

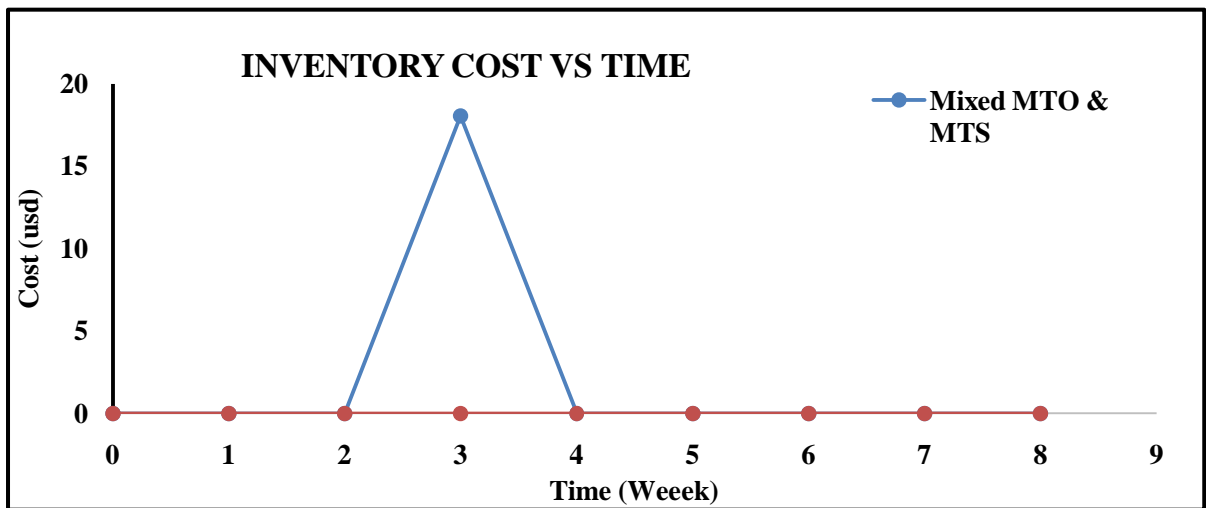

Figure 10: Comparison between Inventory Cost VS Time between Mixed MTO & MTS production Process and MTO Production Process

Figure 10 shows that the inventory cost of the MTS production system remains zero till the eighth week. But the cost of mixed MTO & MTS is highest in the third week and the fourth week inventory cost becomes zero. From the table it is seen that the inventory cost of mixed MTO & MTS is 18 units.

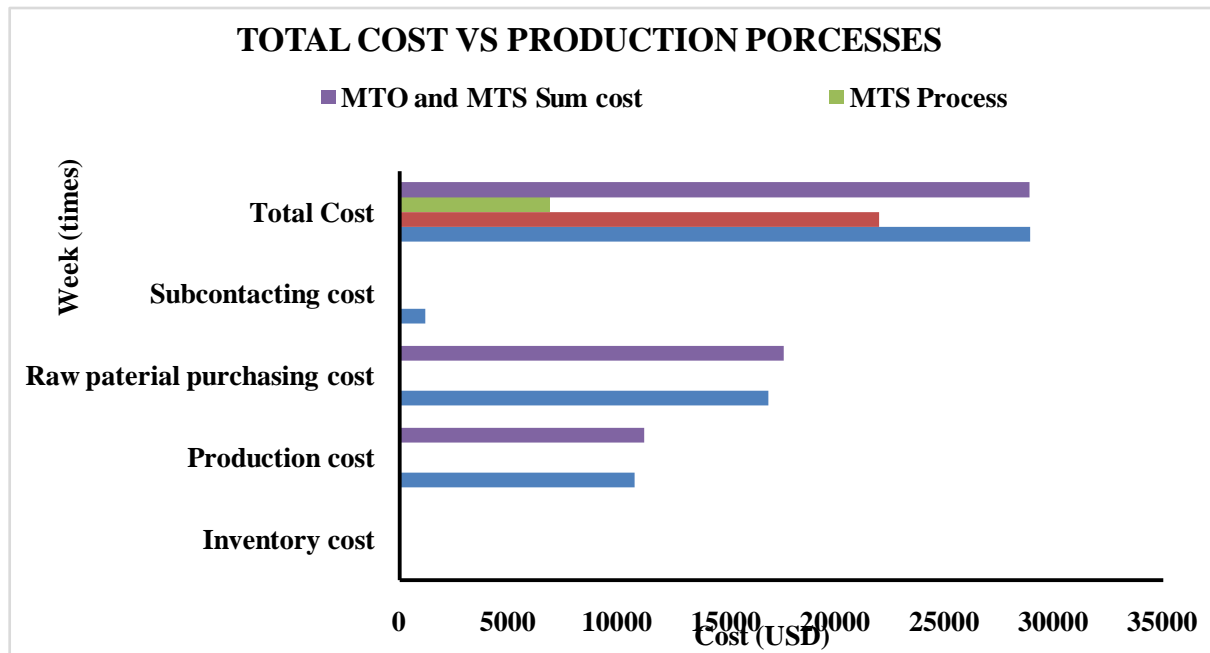

Figure 11: Comparison between the total cost VS Production processes

Figure 11 shows the total production costs. In the mixed MTO & MTS system the production cost is 28894.67 which is greater than the cost 28864.72 of the MTO process. The subcontracting cost is only found in mixed MTO & MTS processes as the model shows. It is beneficial for a plant if any plant follows the mixed production system. Because if they follow the separate plant, they need to consider the multiple fixed cost which will be greater than the single fixed cost for Mixed MTO & MTS production process in a single plant.

## VI. CONCLUSIONS

The major objectives of this research are lot sizing and mixed integer linear programming for an industrial scenario in Bangladesh. Several industries, including apparel, food, steel, and woods, were reviewed to see where output was deficient. By reviewing those industries, the common phenomena that happened is either MTO or MTS process. By following an individual process those industries imply in either the backlog of customer orders or the lagging of the lead time or failing to adopt the proper lot sizing. For those reasons, this research paper is being introduced to get rid of those problems and to maintain a proper production flow. With a mixed MTO and MTS process, an individual industry can consider the disadvantages of MTO and MTS and thus can reach a considerable point where those problems will be at a low level and the achievement will be at a greater position. The model is termed as a mixed integer linear programming model. The model will help to choose the proper lot sizing and to optimize the cost of production.

### a) Recommendation

There is no shortage cost that is included here. All of the variables are restricted to be integers. However, if a quadratic term in the objective function contains, the problem will be termed as a Mixed Integer Quadratic Programming (MIQP) from the Mixed Integer Linear Programming.

In this model, some improvements have been done. But some more improvements could not be done because of insufficient data that was very important for improving the model. More things can be implemented in this model for future recommendation. Like-

1. Shortage cost
2. Supplier selection
3. Discount model.

Shortage cost can also be added in this MILP model. But we failed to find this kind of industry in our country so that we could not generate that data to implement this in our model. Generally, an industry has one or more reliable suppliers and sometimes the number differs from industry to industry. They buy raw materials from that reliable supplier. Sometimes they had to rely on different suppliers if their regular supplier cannot deliver their raw material for facing problems or unwanted situations.

In that case, the supplier selection model has to apply for supplier selection to optimize the cost. So, the supplier selection model can be added with this model for development. Discount models can also be applied in this model. Like Quantity discount model, Volume discount model and Dividend discount model. We could not find that type of industry for applying all these models and collecting the data. But if the data can be

managed, this type of work will surely develop the model a lot. By applying this model, this model can be enriched more fluently and accurately.

#### b) Declarations

##### Availability of Data and Material

All the data generated or analyzed during this study are included in this paper. Data tables include all raw data conducted via the used software (Lingo 18.0), which has been further analyzed via the paper sections.

##### Competing Interests

The authors declare that they have no competing interests.

##### Funding

This study received no funding from any resource.

##### Authors' Contributions

All the authors of this paper contributed to the manuscript and have read and approved the final version. Each of them contributed to outline the study idea, designed the methodology, performed the literature review, conducted the simulation and its analysis, and responsible for writing the manuscript details, figures, and revisions.

## ACKNOWLEDGEMENTS

This research was partially supported by SAMAD sweaters Ltd., Bangladesh.

##### List of Abbreviations

MTO	Make to order MTO
MTS	Make to stock
ATO	Assemble to order
ERP	Enterprise Resource Planning
ETO	Engineer to Order
WIP	Work in process
OEE	Overall Equipment Effectiveness
JIT	Just-in-time
MRP	Materials Requirements Planning
VMI	Vendor Management Inventory
DRP	Distribution Resource Planning
EOQ	Economic Order Quantity

## REFERENCES RÉFÉRENCES REFERENCIAS

- Adan, I., & Van Der Wal, J. (n.d.). *COMBINING MAKE TO ORDER AND MAKE TO STOCK*.
- Amorim, P., Antunes, C. H., & Almada-Lobo, B. (2011). Multi-Objective Lot-Sizing and Scheduling Dealing with Perishability Issues. *Ind. Eng. Chem. Res.* 50, 3371–3381. <https://doi.org/10.1021/ie101645h>.
- Aslan, B., Stevenson, M., & Hendry, L. C. (2014). *The applicability and impact of Enterprise Resource Planning (ERP) systems: Results from a mixed method study on Make-To-Order (MTO) companies*. <https://doi.org/10.1016/j.compind.2014.10.003>.
- Günalay, Y. (2011). Efficient management of production-inventory system in a multi-item manufacturing facility: MTS vs. MTO. *Int J Adv Manuf Technol*, 54, 1179–1186. <https://doi.org/10.1007/s00170-010-2984-9>.
- Gupta, D., & Benjaafar, S. (2010). *IIE Transactions Make-to-order, make-to-stock, or delay product differentiation? A common framework for modeling and analysis*. <https://doi.org/10.1080/07408170490438519>.
- Kalantari, M., Rabbani, M., & Ebadian, M. (2011). A decision support system for order acceptance/rejection in hybrid MTS/MTO production systems. *Applied Mathematical Modelling*, 35, 1363–1377. <https://doi.org/10.1016/j.apm.2010.09.015>.
- Kanda, S., Takahashi, K., & Morikawa, K. (2015). A flexible service rule for the dynamic make-to-stock/make-to-order hybrid production system. *Procedia Manufacturing*, 2, 46–50. <https://doi.org/10.1016/j.promfg.2015.07.009>.
- Karabağ, O., & Gökğür, B. (2022). Integrated optimisation of pricing, manufacturing, and procurement decisions of a make-to-stock system operating in a fluctuating environment. *International Journal of Production Research*. <https://doi.org/10.1080/00207543.2022.2152127>.
- Kotayet, W., Eltawil, A. B., & Fors, M. N. (n.d.). *A HIERARCHICAL PRODUCTION PLANNING FRAMEWORK FOR THE TEXTILE INDUSTRY WITH MAKE TO ORDER AND MAKE TO STOCK CONSIDERATIONS*.
- Micieta, B., Howaniec, H., Binasova, V., Kasajova, M., & Fusko, M. (2021). Increasing Work Efficiency in a Manufacturing Setting Using Gemba Walk. *European Research Studies Journal*, XXIV (Special Issue 4), 601–620. <https://doi.org/10.35808/ersj/2792>.
- Mridha, J. H., Chowdhury, S. E., Hossen, M. S., & Hosen, M. I. (2022). *Analysis of the Competitiveness of Bangladesh RMG Sector Using Porter's Diamond Model*. 9(4), 638–649. <https://doi.org/10.5281/zenodo.7187747>.
- Najhan, A., Nagib, M., Naufal Adnan, A., Ismail, A., Hayati, N., Halim, A., & Khusaini, N. S. (2016). *The Role of Hybrid Make-to-Stock (MTS)-Make-to-Order (MTO) and Economic Order Quantity (EOQ) Inventory Control Models in Food and Beverage Processing Industry Related content The Role of Hybrid Make-to-Stock (MTS)-Make-to-Order (MTO) and Economic Order Qu.* <https://doi.org/10.1088/1757-899X/160/1/012003>.
- Noorwali, A. (2014). Apply MTS-MTO & Rule Base in Food Flow Processing System. *International Journal of Scientific & Engineering Research*, 5(1).
- Owner. (n.d.). *joint symposium 2013*.
- Rabbani, M., & Dolatkhah, M. (2017). *International Journal of Advanced Logistics Simultaneous*

- production planning of make-to-order (MTO) and make-to-stock (MTS) products using simulation optimization. Case study: Soren Restaurant Simultaneous production planning of make-to-order (MTO) and ma. *International Journal of Advanced Logstlcs*. <https://doi.org/10.1080/2287108X.2017.1361290>.
16. Rafiei, H., & Rabbani, M. (2014). Hybrid MTS/MTO order partitioning framework based upon fuzzy analytic network process. *Applied Soft Computing*, 19, 312–321. <https://doi.org/10.1016/j.asoc.2014.02.024>.
  17. Rafigh, P., Akbari, A. A., Bidhandi, H. M., & Kashan, A. H. (2022). A sustainable supply chain network considering lot sizing with quantity discounts under disruption risks: centralized and decentralized models. *Journal of Combinatorial Optimization*, 44(3), 1387–1432. <https://doi.org/10.1007/s10878-022-00891-w>.
  18. Shao, X.-F., & Dong, M. (2012). Comparison of order. *International Journal of Production Research*, 50(7). <https://doi.org/10.1080/00207543.2011.562562>.
  19. Smith, M. L. (2020). Production scheduling. *Geologic and Mine Modelling Using Techbase and Lynx*, 355–386. <https://doi.org/10.1201/9781003077978-8>.
  20. Soman, C. A., Van Donk, D. P., & Gaalman, G. (2004). Combined make-to-order and make-to-stock in a food production system. In *Int. J. Production Economics* (Vol. 90).
  21. Wu, M.-C., Jiang, J.-H., & Chang, W.-J. (2008). Scheduling a hybrid MTO/MTS semiconductor fab with machine-dedication features. *Int. J. Production Economics*, 112, 416–426. <https://doi.org/10.1016/j.ijpe.2007.04.008>.
  22. Youssef, K. H., Van Delft, C., & Dallery, Y. (2017). INTERNATIONAL TRANSACTIONS IN OPERATIONAL RESEARCH Priority optimization and make-to-stock/make-to-order decision in multiproduct manufacturing systems. *Intl. Trans. in Op. Res*, 0, 1–21. <https://doi.org/10.1111/itor.12464>.
  23. Zakeri, B., Paulavets, K., Barreto-Gomez, L., Echeverri, L. G., Pachauri, S., Boza-Kiss, B., Zimm, C., Rogelj, J., Creutzig, F., Üрге-Vorsatz, D., Victor, D. G., Bazilian, M. D., Fritz, S., Gielen, D., McCollum, D. L., Srivastava, L., Hunt, J. D., & Pouya, S. (2022). Pandemic, War, and Global Energy Transitions. *Energies*, 15(17), 1–23. <https://doi.org/10.3390/en15176114>.
  24. Zhang, T., Zheng, Q. P., Fang, Y., & Zhang, Y. (2015). Multi-level inventory matching and order planning under the hybrid Make-To-Order/Make-To-Stock production environment for steel plants via Particle Swarm Optimization q. *COMPUTERS & INDUSTRIAL ENGINEERING*, 87, 238–249. <https://doi.org/10.1016/j.cie.2015.05.001>.



GLOBAL JOURNAL OF RESEARCHES IN ENGINEERING: J  
GENERAL ENGINEERING  
Volume 23 Issue 1 Version 1.0 Year 2023  
Type: Double Blind Peer Reviewed International Research Journal  
Publisher: Global Journals  
Online ISSN: 2249-4596 & Print ISSN: 0975-5861

## Determination of Best Nutritional Conditions for a Monoclonal Antibody-Producing Cell Line based on a Multivariate Data Analysis Approach

By Erick Hernández, Lisandra Calzadilla, Arturo Toledo, Osvaldo Gozá, Matthias Pietzke, Alexei Vazquez, Giovanni Rodríguez, Anelis Quintana, Kalet Leon & Tammy Boggiano

*Technological University of Havana José Antonio Echeverría*

**Abstract-** The design of mammalian cell culture processes as technological platform for monoclonal antibody (mAb) production is a complex task mainly due to partial knowledge of culture media composition impact on process outcomes. Faced with this problem, the present work aimed to characterize the metabolic profile during the early culture at lab-scale of a specific cell line transfected to obtain a monoclonal antibody (mAb) of therapeutic interest in the treatment of cancer, seeking most favorable nutritional conditions. The experimental design, based on the use of four different media in a two-liter scale culture, provided data on the content of 19 metabolites, cell concentration, and mAb concentration over the course of batches, where in the first case measurements were performed with liquid chromatography-mass spectrometry (LC-MS) as an advanced laboratory analytical support.

**Keywords:** *mammalian cell culture, metabolic profile, data-driven modeling, principal component analysis, soft independent modeling of class analogy, partial least square regression.*

**GJRE-J Classification:** FOR Code: 091599



*Strictly as per the compliance and regulations of:*



© 2023. Erick Hernández, Lisandra Calzadilla, Arturo Toledo, Osvaldo Gozá, Matthias Pietzke, Alexei Vazquez, Giovanni Rodríguez, Anelis Quintana, Kalet Leon & Tammy Boggiano. This research/review article is distributed under the terms of the Attribution-NonCommercial-NoDerivatives 4.0 International (CC BY-NC-ND 4.0). You must give appropriate credit to authors and reference this article if parts of the article are reproduced in any manner. Applicable licensing terms are at <https://creativecommons.org/licenses/by-nc-nd/4.0/>.



# Determination of Best Nutritional Conditions for a Monoclonal Antibody-Producing Cell Line based on a Multivariate Data Analysis Approach

Erick Hernández <sup>α</sup>, Lisandra Calzadilla <sup>σ</sup>, Arturo Toledo <sup>ρ</sup>, Osvaldo Gozá <sup>ω</sup>, Matthias Pietzke <sup>¥</sup>, Alexei Vazquez <sup>§</sup>, Giovanni Rodríguez <sup>χ</sup>, Anelis Quintana <sup>ν</sup>, Kalet Leon <sup>θ</sup> & Tammy Boggiano <sup>ζ</sup>

**Abstract-** The design of mammalian cell culture processes as technological platform for monoclonal antibody (mAb) production is a complex task mainly due to partial knowledge of culture media composition impact on process outcomes. Faced with this problem, the present work aimed to characterize the metabolic profile during the early culture at lab-scale of a specific cell line transfected to obtain a monoclonal antibody (mAb) of therapeutic interest in the treatment of cancer, seeking most favorable nutritional conditions. The experimental design, based on the use of four different media in a two-liter scale culture, provided data on the content of 19 metabolites, cell concentration, and mAb concentration over the course of batches, where in the first case measurements were performed with liquid chromatography-mass spectrometry (LC-MS) as an advanced laboratory analytical support. The corresponding data-driven models, as a result of integrating Principal Component Analysis (PCA), Soft Independent Modeling of Class Analogies (SIMCA) and Partial Least Square Regression (PLSR) methods, revealed the actual difference among media regarding cell culture metabolic progression, and allowed to estimate cell growth behavior and mAb generation relative to biomass metabolites composition. Consequently, such an approach facilitated defining the metabolites that benefit the aforementioned cell culture process and those with a negative effect, as well as the choice of media that ensure the best nutritional conditions under technological and economic bases, thereby providing the essential elements for further media optimization.

**Keywords:** *mammalian cell culture, metabolic profile, data-driven modeling, principal component analysis, soft independent modeling of class analogy, partial least square regression.*

## I. INTRODUCTION

The use of mammalian cells to produce monoclonal antibodies (mAbs) has become a widespread practice in the biotechnology domain because of its ability to largely achieve posttranslational modifications and protein folding. However, from an

engineering point of view, the greatest obstacle in designing culture processes including these cells is their high complexity, as currently there is partial knowledge of laws governing such phenomena. On one hand, it shall be taken into consideration the significant amount and intricate sequence of biochemical reactions at the intra and extracellular level, while on the other hand cell environment operational conditions have also their impact on culture process performance regarding product-required quality [1].

A key issue to consider at first is the influence of media metabolites content on cellular growth and mAb generation along the process. As a sound strategy, focusing on culture metabolic profile could start at small scale, leaving the inclusion of cell environment operational variables for further studies at gradually larger scales, where fluctuations of these are better detectable and meaningful to establish culture process state [2,3].

In such research, the design of experimental plans combined with the use of multivariate data analysis (MVDA) tools has shown its advantages, by facilitating the development of data-driven models that integrates input and output variables in all its interrelation complexity, hence providing comprehensive process variability characterization and prediction [4,5].

There is a wide range of MVDA applications that has been described in the biotechnological domain, for instance: cell culture process scales comparability [6,7]; determine the relationship between process parameters and critical quality attributes [8,9]; feeding strategies for metabolic control and improving process robustness [10,11], among others. In addition, MVDA is currently recognized as a useful mean to analyze genomic and proteomic data, as it provides the tools for a significant complexity reduction in data processing [12-14]. Yet, regarding the implementation of MVDA in metabolic studies and media selection, there are still a discrete number of published references that manage to analyze a significant spectrum of metabolites [15-17].

Such praxis is in full correspondence with Quality by Design current paradigm as appointed by The International Council for Harmonisation of Technical Requirements for Pharmaceuticals for Human Use (ICH)

*Author α σ ρ ν θ ζ:* Center of Molecular Immunology, Research and Development Division, Havana, Cuba.

*Author ω:* Technological University of Havana José Antonio Echeverría, Chemical Engineering Faculty, Havana, Cuba.

*Author §:* Cancer Research Beatson Institute, Glasgow, UK. Institute of Cancer Science, University of Glasgow, Glasgow, UK.

*Author ¥ χ:* Cancer Research Beatson Institute, Glasgow, UK.

in the Q8, Q9, and Q10 guidelines, where process understanding acquires a key role for assuring an effective scaling-up exercise toward a successful technology transfer [18].

The present work exposes a MVDA approach for characterizing metabolic profile during the early lab-scale culture of a specific CHO-K1 cell line transfected for obtaining a mAb under study in a two-liter bioreactor, thus determining the most advantageous culture nutritional conditions. Results derived from this research provide a valuable knowledge that shall contribute to subsequent studies as a continuity for achieving culture media optimization and further process scale-up.

## II. MATERIALS AND METHODS

### a) Cell Culture Experiment

A transfected mammalian cell line CHO-K1 developed for expressing the mAb of interest was cultured in a two-liter volume APPLIKON bioreactor equipped with an automatic process control system, using four different protein-free and serum-free media identified as M1, M2, M3 and M4. Main chemical composition of each medium is summarized in Table 1:

Table 1: Composition of culture media in mg per liter

Components	Medium M1	Medium M2	Medium M3	Medium M4
Ala	1.052	1.311	0.952	0.895
Arg	1.562	1.356	1.792	1.640
Asn	3.727	1.371	1.512	1.363
Asp	0.028	0.020	0.702	0.687
Gln	4.236	2.507	5.133	3.745
Glu	0.396	0.514	0.548	0.525
Gly	0.261	0.411	0.549	0.605
Ile	0.104	0.054	1.690	1.539
Leu	2.304	1.359	1.836	1.573
Lys	1.806	1.209	1.367	1.172
Met	0.471	0.298	0.439	0.374
Phe	0.775	0.431	0.051	0.044
Pro	1.207	1.210	0.084	0.089
Ser	1.510	1.373	1.449	1.324
Thr	1.184	0.572	0.835	0.713
Val	1.786	0.913	1.278	1.038
Pyr	1.543	1.044	0.973	0.666
Gluc	24.182	10.887	20.138	17.348

The operation of each run was carried out in batch mode, starting from an inoculum with a concentration greater or equal to  $0.4 \times 10^6$  cells/ml in the medium previously loaded in the bioreactor, and then the process was allowed to carry on until viability was less than 50%. Cell environment culture conditions were set as follows: temperature at  $37 \pm 1^\circ\text{C}$ , dissolved oxygen at  $40 \pm 10\%$  and pH at  $7.2 \pm 0.2$ , as well as an agitation impeller tip speed kept at 1 m/s and aeration rate between 0.005 – 0.0075 vessel volumes per minute (vvm).

### b) Analytical Support

Several measurements were obtained off line from culture supernatant samples taken over the course of each batch:

- The concentration of metabolites was measured through a Liquid Chromatography-Mass Spectrometry (LC-MS) analytical method. The equipment configuration was composed of Heater Electro Spray Ionization source, ORBITRAP detector (AGILENT, USA) and ZIC-pHILIC column (MERCK MILLIPORE, Germany). All standard reagents used for quantification of the 19 metabolites involved in

the process were from SIGMA ALDRICH (MERCK MILLIPORE, Germany).

- The mAb concentration (IgG) was determined by an own-developed ELISA sandwich method. In summary, 96-microwell plates were previously coated with human PD-1 and kept overnight at  $4^\circ\text{C}$ . Next, the samples and the standard were added to the plates and incubated at  $37^\circ\text{C}$  for one hour. Subsequently, an anti-Human IgG antibody conjugated with alkaline phosphatase was added to the plate and incubated at  $37^\circ\text{C}$  for one hour. Then, p-Nitrophenyl phosphate substrate was added to the plate and after 30 minutes, the plates were read by means of a spectrophotometer (JASCO, Japan) at 405 nm.
- Concentration of cells (X) was obtained from visual counting through optical microscopy, using the trypan blue dye exclusion method in a Neubauer chamber (MARIENFELD, Germany).

### c) Data Preparation

All batch measurements collected over time were organized in a single two-way data matrix of 756 elements in a Variable-Wise Unfolded (VWU) array,

where each column is a single variable, and each row contains measurements for the variables at a specific time point in correspondence to batches [19,20]. Notation of scored samples (S) represents first number as the specific culture medium in the batch, and second number as the time instant (T) of sampling (for example, S21 score is the first sample taken at time T1 of batch run using M2). The work matrix can be seen here.

d) *Data Processing*

MVDA was applied with the following sequence [21]:

- Use of descriptive statistic and run chart graphics for a preliminary look to the dataset in order to identify variable fluctuations, tendencies and potential correlations between them.
- Data auto-scaling standardization (ratio of centered mean and the standard deviation) in order to avoid prevalence of variables due to their magnitude.
- Use of Principal Component Analysis (PCA) for dimensionality reduction in a few independent latent variables or Principal Components (PC) in order to differentiate input variables according to their real impact on process variability and probable correlation between each other, as well as identification of score's trends.
- Use of Soft Independent Modeling of Class Analogies (SIMCA) method [22,23] to confirm differences among nutritional media according to batches progress.
- Use of Partial Least Square Regression (PLSR) to find the potential interrelation between cell and IgG concentration as output variables vs. supernatant metabolites content as input variables, focusing on data from the exponential phase of batch cell growth.

It should be noted that given the limitations to replicate experiments in this early stage of development, an internal full cross validation (leaves out only one sample at a time) procedure was applied to appraise

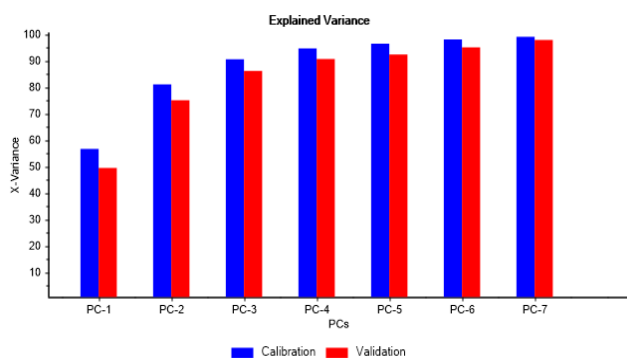

(a)

PLSR model ability of estimation rather than prediction, which is admissible for the purposes of the present work [21,24].

An available UNSCRAMBLER X version 10.4 software (CAMO Software AS) was used to run the above MVDA methods, which does not mean a preference among other applications.

III. RESULTS

A first look at batch culture metabolic dataset by applying descriptive statistics and run charts showed that all measured metabolites could be relevant for the study, as they exhibit a substantial concentration variability that can potentially impact cell culture performance, also noticing certain degree of correlation between metabolites, which in some cases is considerable. Fluctuations detected in those univariate graphs also contributed to multivariate analysis subsequently.

Additionally, it is also detected a difference of magnitude among metabolites concentration, more significant in the case of Glucose and Lactate (see a summary of univariate statistic graphs here). Since other metabolites can have a greater influence even at lower proportion in the culture as known elsewhere [25], data were standardized via auto-scaling in order to assure a proper balance among variables.

a) *Characterization of Process Metabolic Progression through PCA*

A model expressed in three principal components points out as a proper choice, covering around 90% of data variance in calibration and about 86% in validation, as shown in Figure 1a. In addition, no outliers were detected, as can be noticed in Figure 1b. Hence, such PCA model can be considered as representative of culture metabolic variability and adequate for further analysis.

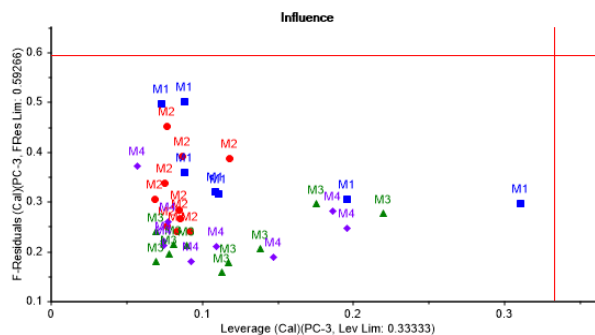

(b)

Figure 1: Explained variance and influence graphs illustrating PCA model adjustment to dataset. (a) X-Variance vs. PC's showing calibration and validation data variance properly covered by 3 PC's. (b) F-residuals vs. leverage showing no outliers

From Figure 2a it can be appreciated that those metabolites consumed throughout the batches, such as Asn, Gln, Leu, Lys, Met, Ser, Thr, Val, Gluc, Pyr, and produced as Gly, can be grouped in PC-1, having correlation loadings outside the margin of  $\pm 0.7$ , which

in regular practice is indicative of the greatest contribution to process variability. Furthermore, consumed metabolites show a strong correlation among each other.

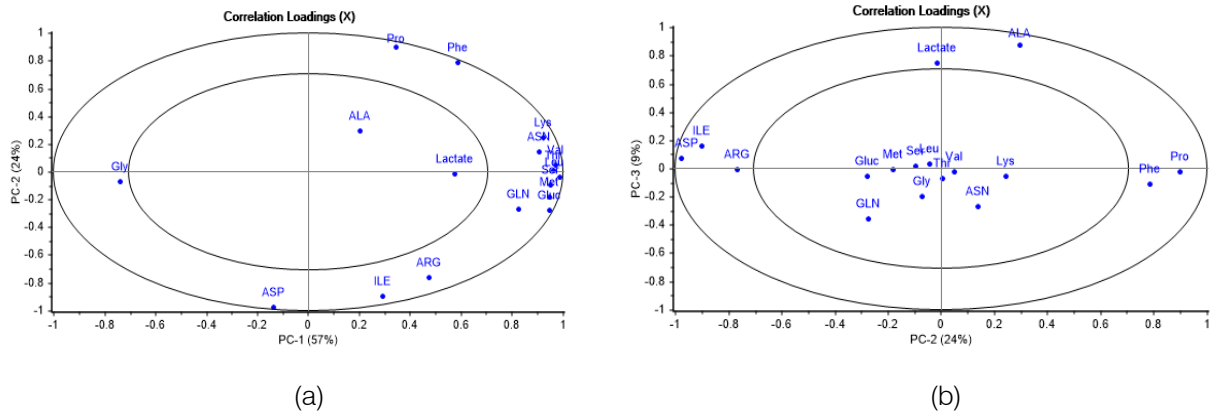

Figure 2: Correlation loadings graphs. (a) Second vs. first principal component, emphasizing impact on process variability and correlation of metabolites grouped along PC-1. (b) Third vs. second principal component, showing differences in influence on process variability of other metabolites grouped along PC-2 and PC-3

On the other side, it was found that PC-2, being the second major contributor to process variability, includes other metabolites such as Phe, Pro, Arg, Ile and Asp, having a notable disparity in initial concentration due to media differences in composition, as can be seen in Figure 2b. Moreover, in the same figure is observed that Lactate and Ala metabolites, which are first produced and later consumed during the batch course, are gathered in PC-3, with a less important relative impact on cell culture variability.

from right to left along PC-1 axis, with no remarkable differences in metabolites consumption or production patterns among nutritional media.

Concurrently, looking in the direction of PC-2 axis, batches using culture media M1 and M2 are very similar in tendency, as well as those using M3 and M4, both trends being distinguishable between each other. In addition, Figure 3b confirms there are metabolites first produced and later consumed, showing almost no differences in content among batches as already mentioned.

As a complement to the above, the score plot in Figure 3a shows a well-defined trajectory of the batches

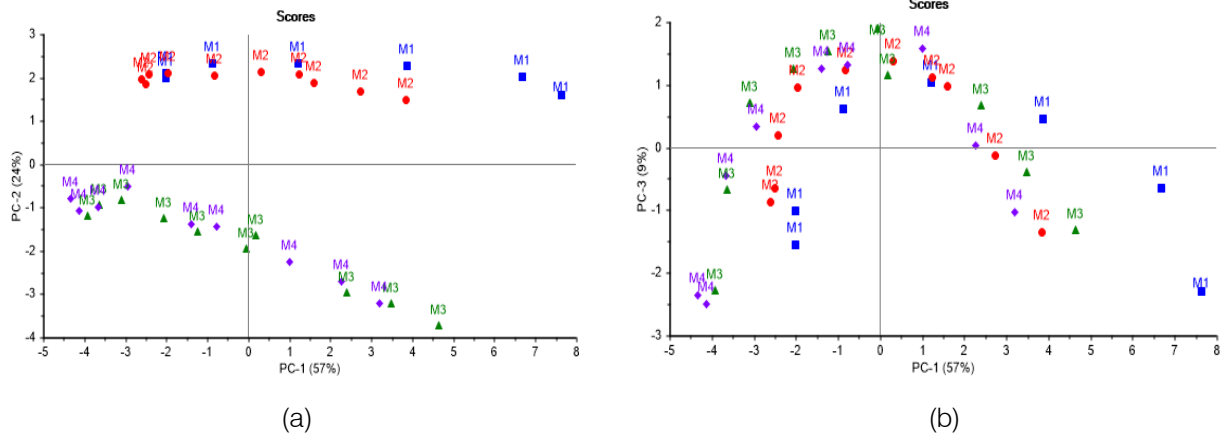

Figure 3: Score graphs illustrating batches progression. (a) Second vs. first principal component showing no differences in consumption or production of metabolites among nutritional media. (b) Third vs. first principal component confirming there are metabolites first produced and later consumed with almost no difference in content among batches

A simultaneous view of both, scores and correlation loadings graphs, combined as a bi-plot in Figure 4a and Figure 4b, shows that culture samples are

rich in those metabolites consumed since batches start, while Gly as the one produced, reach its higher concentration at the end of the culture.

Looking through PC-2 axis it is more evident that M1 and M2 have a significant initial content of Phe and Pro, as well as M3 and M4 in Arg, Ile and Asp.

Further, Lactate and Ala come to their highest concentration in the middle of culture batches, being corroborated its production at first and consumption later on.

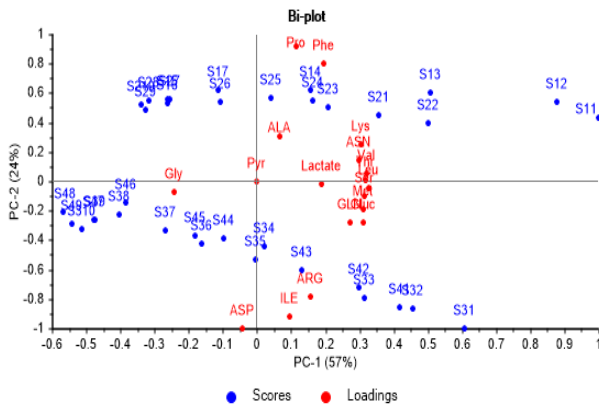

(a)

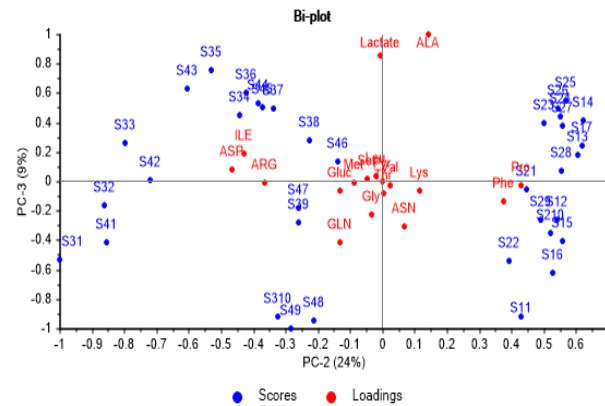

(b)

Figure 4: Correlation loadings and scores biplot graphs. (a) Second vs. first principal component, showing significance of metabolites consumed and produced during the course of batches. (b) Third vs. second principal component, showing culture media have a significant content from the start in some metabolites

b) Determining Media Differences through SIMCA Method

By requiring a more precise differentiation among culture media concerning batches performance than the one appreciated in the PCA score plot, a supervised classification method such as SIMCA was applied, using the individual PCA models of each batch.

Through the Coomans plot shown in Figure 5, it is confirmed that media M1 and M2 are segregated into different classes and at the same time are quite distinct to media M3 and M4, while the latter are rather similar. Such result is consistent with the fact that media M1 and M2 share 30% of their initial composition, whereas M4 is the same medium M3 modified with some additives.

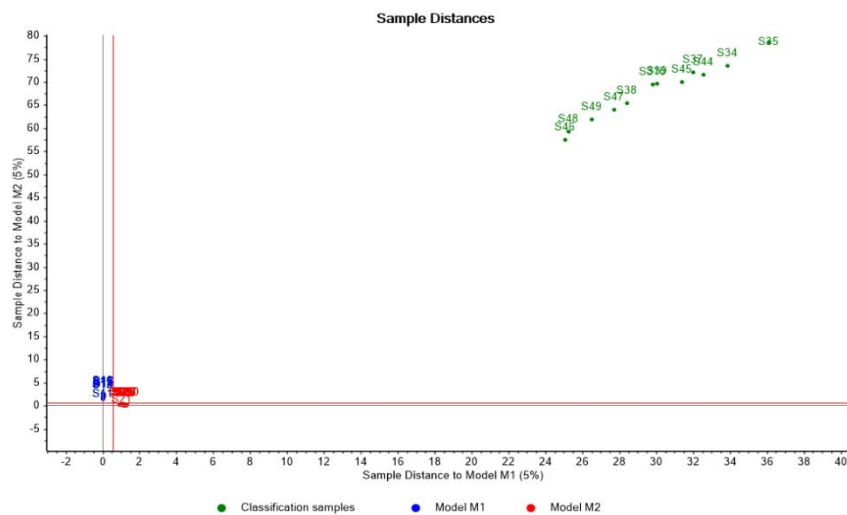

Figure 5: Coomans graph from Soft Independent Modeling of Class Analogy confirming differences among culture media relative to batches performance

c) Determining Metabolites Influence on Cell Growth and mAb Production through PLSR

Metabolite concentrations relationship with cell and IgG concentrations was analyzed via PLSR using data from the exponential phase of batch cell growth, given its relevance in cell culture process [26]. Consequently, a logarithmic transformation of cell

growth data was applied looking for an approximation to a linear behavior.

Following PLSR procedure, a Martens uncertainty test together with full cross validation was applied in order to find input variables with more significant impact on model's response [27,28]. In this regard, Figure 6a and Figure 6b show in striped-shaded

bars Arg, Gln, Ile, Leu, Lys, Phe, Ser, Val and Lactate metabolites with statistically significant weighted regression coefficients, hence with a relevant influence

on cell growth and mAb generation. The rest of the metabolites can be discarded as they do not provide useful information and could lead to model overfitting.

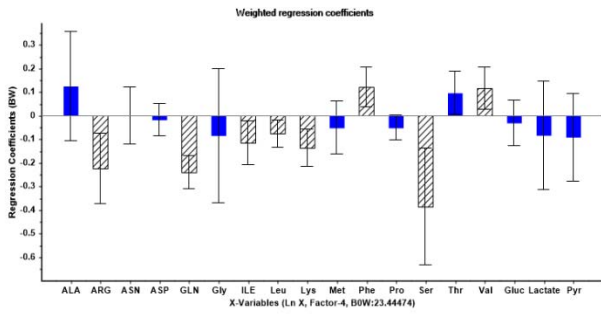

(a)

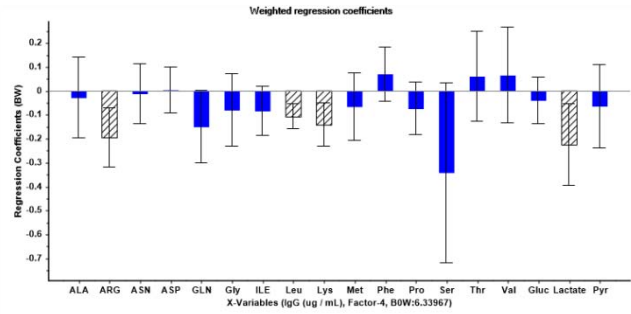

(b)

Figure 6: Graphs derived from uncertainty test for four factors PLSR model. (a) Weighted regression coefficients relative to logarithmic cell concentration showing most significant metabolites in stripe-shaded bars. (b) Weighted regression coefficients relative to IgG concentration showing most significant metabolites in stripe-shaded bars

PLSR model restructured on this basis reach a proper fit by using three factors, as observed in Figure 7a and Figure 7b. In this case, model's R-Square is

around 91% in calibration and about 87% in validation, showing good data adjustment and acceptable ability of estimation for the purposes of subsequent analysis.

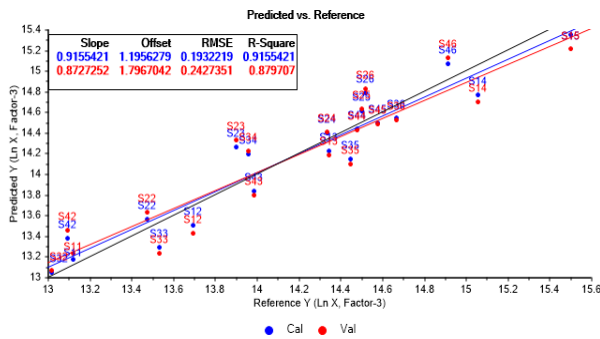

(a)

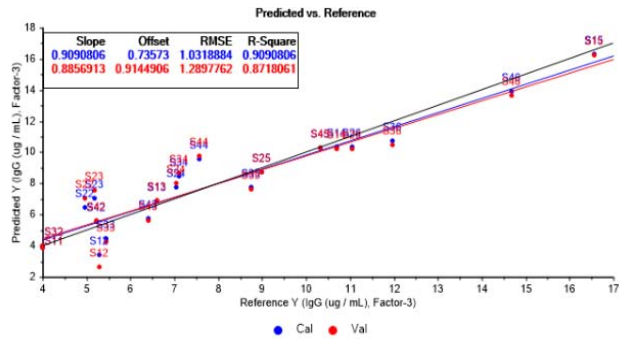

(b)

Figure 7: Predicted vs. reference values graphs from PLSR model adjustment based in three factors. (a) Relative to logarithmic cell concentration. (b) Relative to IgG concentration

The correlation loadings X – Y plots shown in Figure 8a and Figure 8b, reassert that incidence pattern of metabolites correlated with the output variables is comparable with the obtained from PCA model as well. It is also noticed that cell growth is closely interrelated to mAb generation, as evidence of a substantial interaction between them.

Complementarily, Figure 9 summarize those key metabolites influence on cell culture performance, based on Martens uncertainty test likewise.

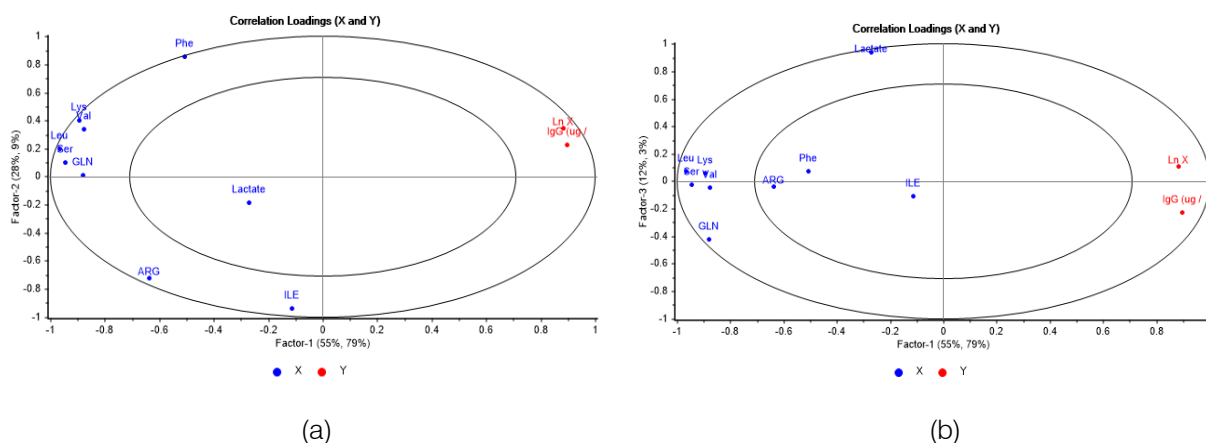

Figure 8: Correlation loadings X – Y graphs showing metabolites incidence on logarithmic cell concentration and IgG concentration. (a) Second vs first factor. (b) Third vs. first factor

From the analysis integrating both Figures 8a - 8b and Figure 9 it is inferred that metabolites linked to first factor, Lys, Leu, Ser and Gln contribute to cell growth and mAb generation as they are consumed, while Val only contributes to cell growth. In the case of those associated to second factor and related to initial concentration in media, Phe has a positive effect on cell growth, whereas Arg and Ile have a reverse effect on

both cell growth and mAb production. In view of these findings, extra experiments shall be done to consolidate knowledge on the actual influence of their initial concentrations in the culture. Concerning Lactate metabolite linked to third factor, it does not show a significant incidence on cell growth, but on mAb concentration in a negative way, which shall be discussed later.

Specific metabolic feature on cell culture variability	Cell growth	mAb production
<b>Arginine</b>	-0.2859	-0.2210
<b>Glutamine</b>	-0.2315	-0.0963
<b>Isoleucine</b>	-0.2092	-0.1360
<b>Leucine</b>	-0.1442	-0.1757
<b>Lysine</b>	-0.1154	-0.1337
<b>Phenylalanine</b>	+0.0798	+0.0297
<b>Serine</b>	-0.2050	-0.2512
<b>Valine</b>	-0.0842	-0.0758
<b>Lactate</b>	-0.0237	-0.2952

† Red/Green color indicates metabolite major/minor impact.

†† (+/-) symbol in weighted regression coefficients indicates metabolite direct/inverse effect.

Figure 9: Influence matrix summarizing key metabolites impact on cell culture process according to weighted regression coefficients

As a matter of verifying model's estimation ability for cell growth and mAb production, predicted with deviation per batch graphs were obtained as shown in Figure 10a and Figure 10b, by plotting reference values along with calibration and validation computations throughout the four batches in the order of score samples. Indeed, both graphs show a proper model fit, bounded to used dataset.

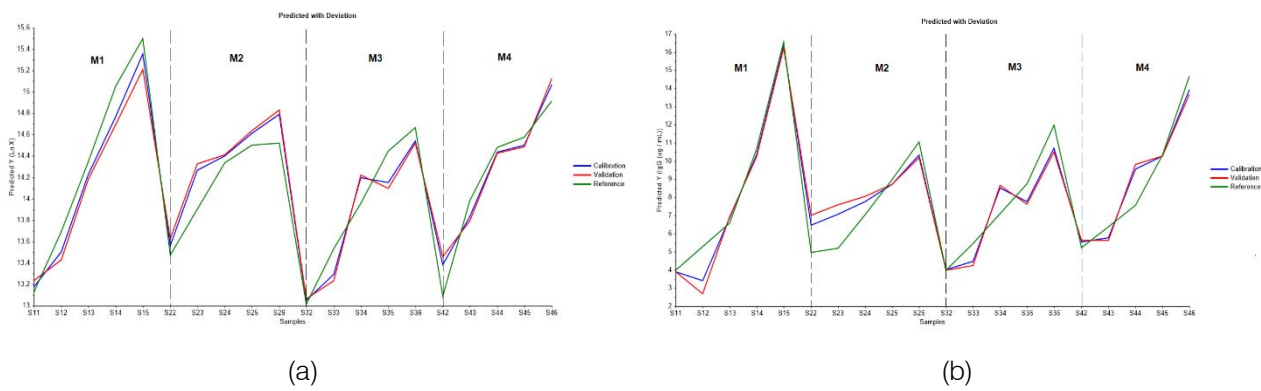

Figure 10: Predicted with deviations graphs showing model's estimation ability by plotting references values, calibration and validation curves throughout the four batches in the order of score samples from M1 to M4. (a) Relative to logarithmic cell concentration. (b) Relative to IgG concentration

#### IV. DISCUSSION

The above results, derived from early lab experimental work, depict the first insights into this particular cell culture system, in correspondence with its inherent metabolic complexity.

It was found that Lys, Leu, Val, Gln, and Ser metabolites have a major impact onto this cell culture process. In the case of Lys, Leu and Val, they are consistent with their role of being essential amino acids, in conformity with current knowledge so far [25]. Therefore, depletion of this substances could take place during the course of cell culture batches, and given the cells inability to produce them, the culture could end the exponential growth phase prematurely. Likewise, Gln is widely known as a key metabolite in mammalian cell culture due to its important function as a source of carbon and nitrogen, in addition to the influence it exerts in delaying cell death [29]. Concerning Ser metabolite, is also known to be relevant for cell metabolism. A deficiency on this metabolite in the culture can trigger several negative scenarios causing an imbalance in the tetrahydrofolate cycle, which is detrimental to cell growth [30]. Moreover, absence of this metabolite can bring on phosphatidylserine formation, a component involved in signaling and detection of cell death by apoptosis.

On the other hand, it was also found Arg, Ile and Phe metabolites as the second major contributors to cell culture behavior regarding their initial content in culture media. In fact, culture performance depends on cells capability to sense somehow nutrients availability at batch start, thereby stimulating the metabolic interactions that lead to primary growth and mAb generation concurrently. Hence, in the specific case of Arg and Ile it should be elucidated if their concentration at start exceeds the limit that leads to culture inhibition in further studies, which shall also include Phe in search of media optimization.

In regard to Lactate, it is well known that glucose/glutamine metabolism leads to formation and accumulation of this metabolite, which is more

accentuated in cell culture batch mode [31]. Although in this cell culture system has a minor effect on cell growth, it shows a significant negative impact on mAb generation. This could be due to the potential effect of Lactate to divert cells specific metabolic pathways that subsequently lead to a decrease in its specific productivity [32].

Comparing these results with those obtained in other references, the substantial diversity and variability in CHO cell culture process is corroborated [33-35]. In some cases, a specific amino acid is relevant in a positive way, while in others is quite the opposite, or does not impact the process at all in certain cases. It may even be the case that most favorable cell culture nutritional conditions to ensure maximum cell growth may not necessarily be the best for cell productivity and product quality [36]. Thence the importance of proper culture media optimization based on cell specific nutritional profile understanding.

Given the difference among culture media derived from the above results, it can be deduced for this cell culture process that M1 provides most favorable nutritional conditions in terms of the content of those amino acids found as key contributors, followed by M4 in order. Paradoxically, from the economical point of view M1 have the highest unit cost, while M4 have the lowest. Hence, the alternative of using M4 becomes attractive if supplemented with Leu, Lys, Val and Phe in similar proportions as in M1, because it already has similar contents of Ser and Gln.

It is recognized that predictability of the MVDA models used for analysis is limited given the lack of additional data for performing an external validation. Nevertheless, the internal validation carried out on such models with the available dataset evidenced they have an adequate estimation ability to provide, in this early research, valuable insights on the cell culture system in question, thus assuring the necessary groundwork for further studies.



## V. CONCLUSION

The applied MVDA approach showed its potential by providing advanced data processing tools for achieving this study. It facilitated the understanding of metabolic variability in this particular cell culture process in batch mode at an early experimental stage, as well as disclosing the difference among culture media according to their nutritional effect on batches. In addition, the PLSR model derived from the available dataset contributed to identify those key metabolites that benefit cell growth and mAb production and those with a negative incidence, thus giving a rationale for the proper choice of culture media with most advantageous nutritional conditions. Finally, these outcomes offer the essentials needed for subsequent media optimization, which shall consolidate future scale-up studies.

### Funding

This work has received funding from the European Union Horizon 2020 Research and Innovation Program MSCA-RISE-2016 under grant agreement No. 734439 INFERNET.

## ACKNOWLEDGMENTS

The authors deeply thank the contribution of Center of Molecular Immunology Research and Development Division in providing important resources and equipment, as well as the contribution of the support staff to this study. In addition, authors also thank the Core Services and Advanced Technologies at the Cancer Research UK Beatson Institute (CRUK A17196), with particular thanks to the Metabolomics Unit.

### Conflicts of Interest

The authors have no conflict of interest to declare regarding this research.

### Abbreviations

Ala: Alanine	Ile: Isoleucine
Arg: Arginine	Leu: Leucine
Asn: Asparagine	Lys: Lysine
Asp: Aspartate	Met: Methionine
CHO: Chinese Hamster Ovary	Phe: Phenylalanine
Glu: Glutamate	Pro: Proline
Gluc: Glucose	Pyr: Pyruvate
Gln: Glutamine	Ser: Serine
Gly: Glycine	Thr: Threonine
IgG: Immunoglobulin G	Val: Valine

### Highlights

- A strategy is conceived and successfully applied in the primary research of a monoclonal antibody (mAb)-producing cell line of special interest in cancer therapy, in which lab-scale experiments are focused specifically on metabolic characterization by testing different culture media, thus ensuring the most favorable nutritional conditions from an early

stage of the culture process development as prescribed by Quality by Design.

- Advanced analytics implemented to support the experimental work provides, with sufficient reliability, the concentration during biochemical reactions course of at least 19 metabolites through liquid chromatography-mass spectrometry (LC-MS), among other special lab determinations.
- Complexities derived from the analysis of such a volume of experimental data are managed effectively by applying a multivariate data analysis approach to attain data-driven models, which lead to key findings that contribute to understand the metabolic behavior of this particular cell culture process.
- Best nutritional conditions determined at this stage provided the necessary groundwork for subsequent culture media composition optimization. In addition, such practice can be generalized to deal with similar high complex research of this kind in the biotechnological domain.

## REFERENCES RÉFÉRENCES REFERENCIAS

1. Ruiz G, Moreno M, López M, Vega M. Anticuerpos monoclonales terapéuticos. GEN-ES07006, Spain: Spainfo, S.A; 2007.
2. Li F, Vijayasankaran N, Shen A, Kiss R, Amanullah A. Cell culture processes for monoclonal antibody production. *mAbs* 2010;2(5):466-79. <https://doi.org/10.4161/mabs.2.5.12720>.
3. Smith C. Scaling up your cell cultures to bioreactors; cited July 2014. Available from: <https://www.biocompare.com/Editorial-Articles/165203-Scaling-Up-Your-Cell-cultures-to-Bioreactors>. Accessed April 15, 2021.
4. Swarbrick B. Multivariate data analysis for biotechnology, bioprocessing. *Pharm Manuf.* 2014; 13(3):38-43.
5. Rathore AS, Mittal S, Pathak M, Arora, A. Guidance for performing multivariate data analysis of bioprocessing data: pitfalls and recommendations. *Biotechnol Prog.* 2014;30(4):967-73. <https://doi.org/10.1002/btpr.1922>.
6. Kirdar AO, Conner JS, Baclaski J, Rathore AS. Application of multivariate analysis toward biotech processes: case study of a cell-culture unit operation. *Biotechnol Prog.* 2007;23(1):61-7. <https://doi.org/10.1021/bp060377u>.
7. Kirdar AO, Green KD, Rathore AS. Application of multivariate data analysis for identification and successful resolution of a root cause for a bioprocessing application. *Biotechnol Prog.* 2008;24(3):720-26. <https://doi.org/10.1021/bp0704384>.
8. Palermo G, Piraino P, Zucht HD. Performance of PLS regression coefficients in selecting variables for

- each response of a multivariate PLS for omics-type data. *Adv Appl Bioinform Chem.* 2009;2:57-70. <https://doi.org/10.2147/aabc.s3619>.
9. Bhushan N, Rathore AS. Use of multivariate data analysis (MVDA) for generating process understanding from manufacturing data of biotech processes. *Proc Indian natn Sci Acad.* 2011; 77(2):133-42.
  10. Roychoudhury P, O’Kennedy RD, Faulkner J, McNeil B, Harvey LM. Implementing multivariate data analysis to monitor mammalian cell culture processes. *Eur Pharm Rev.* 2013;18(3):15-20.
  11. Konakovsky V, Clemens C, Müller MM, Bechmann J, Berger M, Schlatter S, et al. Metabolic control in mammalian fed-batch cell cultures for reduced lactic acid accumulation and improved process robustness. *Bioengineering* 2016;3(1):1-29. <https://doi.org/10.3390/bioengineering3010005>.
  12. Sokolov M, Soos M, Neunstoecklin B, Morbidelli M, Butté A. Fingerprint detection and process prediction by multivariate analysis of fed-batch monoclonal antibody cell culture data. *Biotechnol Prog.* 2015;31(6):1633-44. <https://doi.org/10.1002/btpr.2174>.
  13. Sokolov M, Ritscher J, McKinnon M, Bielser JM, Brühlmann D, Rothenhäusler D, et al. Robust factor selection in early cell culture process development for the production of a biosimilar monoclonal antibody. *Biotechnol Prog.* 2017;33(1):181-91. <https://doi.org/10.1002/btpr.2374>.
  14. Sokolov M, Morbidelli M, Butté A, Souquet J, Broly H. Sequential multivariate cell culture modeling at multiple scales supports systematic shaping of a monoclonal antibody toward a quality target. *Biotechnol J.* 2018;13(4):1-10. <https://doi.org/10.1002/biot.201700461>.
  15. Rathore AS, Singh SK, Pathak M, Read EK, Brorson KA, Agarabi CD, et al. Fermentanomics: relating quality attributes of a monoclonal antibody to cell culture process variables and raw materials using multivariate data analysis. *Biotechnol Prog.* 2015; 31(6):1586-99. <https://doi.org/10.1002/btpr.2155>.
  16. O’Kennedy RD. Multivariate analysis of biological additives for growth media and feeds. *Bioprocess Int.* 2016; 14(3):18-29.
  17. Zürcher P, Sokolov M, Brühlmann D, Ducommun R, Stettler M, Souquet J, et al. Cell culture process metabolomics together with multivariate data analysis tools opens new routes for bioprocess development and glycosylation prediction. *Biotechnol Prog.* 2020;36(5):e3012. <https://doi.org/10.1002/btpr.3012>.
  18. Luciani F, Galluzzo S, Gaggioli A, Kruse NA, Venneugues P, Schneider CK, et al. Implementing quality by design for biotech products: are regulators on track? *mAbs* 2015;7(3):451-55. <https://doi.org/10.1080/19420862.2015.1023058>.
  19. Mercer E, Mack J, Tahir F, Lovett D. Application of Multivariate Process Modeling for Monitor and Control Applications in Continuous Pharmaceutical Manufacturing. In: Ferreira AP, Menezes JC, Tobyn M, editors. *Multivariate Analysis in the Pharmaceutical Industry.* Academic Press, Elsevier Inc.; 2018:385-407. <https://doi.org/10.1016/B978-0-12-811065-2.00019-9>.
  20. Chiang LH, Leardi R, Pell RJ, Seasholtz MB. Industrial experiences with multivariate statistical analysis of batch process data. *Chemom Intell Lab Syst.* 2006;81:109-19. <https://doi.org/10.1016/j.chemolab.2005.10.006>.
  21. Dunn K. *Process Improvement Using Data.* Release 3ce778, Copyright 2010-2021 Kevin Dunn; 2021.
  22. Branden KV, Hubert M. Robust classification in high dimensions based on the SIMCA Method. *Chemom Intell Lab Syst.* 2005;79(1-2):10–21. <https://doi.org/10.1016/J.CHEMOLAB.2005.03.002>.
  23. Davies AMC, Fearn T. Back to basics: multivariate qualitative analysis, “SIMCA”. *Spectrosc Eur.* 2008; 20(6):15-19.
  24. Berrar D. Cross-validation. *Encyclopedia of Bioinformatics and Computational Biology.* Volume 1. Elsevier; 2019:542-45. <https://doi.org/10.1016/B978-0-12-809633-8.20349-X>.
  25. Carrillo-Cocom LM, Genel-Rey T, Araíz-Hernández D, López-Pacheco F, Lopez-Meza J, Rocha-Pizaña MR, et al. Amino acid consumption in naïve and recombinant CHO cell cultures: producers of a monoclonal antibody. *Cytotechnology* 2015;67:809-20. <https://doi.org/10.1007/s10616-014-9720-5>.
  26. De Alwis DM, Dutton RL, Scharer J, Moo-Young M. Statistical methods in media optimization for batch and fed-batch animal cell culture. *Bioprocess Biosyst Eng.* 2007;30(2):107-13. <https://doi.org/10.1007/s00449-006-0107-7>.
  27. Davies AMC, Uncertainty testing in PLS regression. *Spectrosc Eur.* 2001;13(2):16-19.
  28. Esbensen KH, Swarbrick B. *Multivariate Data Analysis 6th Edition.* Norway: CAMO Software AS; 2018.
  29. Ritacco FV, Wu Y, Khetan A. Cell culture media for recombinant protein expression in chinese hamster ovary (CHO) cells: history, key components, and optimization strategies. *Biotechnol Prog.* 2018; 34(6):1407-26. <https://doi.org/10.1002/btpr.2706>.
  30. Salazar A, Keusgen M, von Hagen J. Amino acids in the cultivation of mammalian cells. *Amino Acids* 2016;48(5):1161-71. <https://doi.org/10.1007/s00726-016-2181-8>.
  31. Ozturk SS, Hu W-S, editors. *Cell culture technology for pharmaceutical and cell-based therapies.* Boca Raton, FL: CRC Press; 2005.
  32. Pereira S, Kildegaard HF, Andersen MR. Impact of CHO metabolism on cell growth and protein production: an overview of toxic and inhibiting

- metabolites and nutrients. *Biotechnol J.* 2018; 13(3):1700499. <https://doi.org/10.1002/biot.201700499>.
33. Altamirano C, Illanes A, Canessa R, Becerra S. Specific nutrient supplementation of defined serum-free medium for the improvement of CHO cells growth and t-PA production. *Electron J Biotechnol.* 2006;9(1):62-8. <https://doi.org/10.2225/vol9-issue1-fulltext-8>.
34. Xing Z, Kenty B, Koyrakh I, Borys M, Pan S-H, Li JL. Optimizing amino acid composition of CHO cell culture media for a fusion protein production. *Process Biochem.* 2011;46(7):1423-29. <https://doi.org/10.1016/j.procbio.2011.03.014>.
35. Torkashvand F, Vaziri B, Maleknia S, Heydari A, Vossoughi M, et al. Designed amino acid feed in improvement of production and quality targets of a therapeutic monoclonal antibody. *PLoS ONE* 2015;10(10):e0140597. <https://doi.org/10.1371/journal.pone.0140597>.
36. Jenkins N, Castro P, Menon S, Ison A, Bull A. Effect of lipid supplements on the production and glycosylation of recombinant interferon-gamma expressed in CHO cells. *Cytotechnology* 1994;15 (1-3):209-15. <https://doi.org/10.1007/BF00762395>.





This page is intentionally left blank



GLOBAL JOURNAL OF RESEARCHES IN ENGINEERING: J  
GENERAL ENGINEERING  
Volume 23 Issue 1 Version 1.0 Year 2023  
Type: Double Blind Peer Reviewed International Research Journal  
Publisher: Global Journals  
Online ISSN: 2249-4596 & Print ISSN: 0975-5861

## New Encryption Algorithm with Improved Security

By Dmitriy Shatokhin

*Abstract-* The design of new cryptographic algorithms, as a rule, has the main goal of improving their resistance to cryptanalysis methods. Since cryptanalysis methods are constantly being improved, when designing crypto algorithms, it becomes necessary to create new non-standard approaches that can effectively resist the existing cryptanalysis methods. This paper describes in detail a new crypto algorithm created using an original technique aimed at radically improving cryptographic strength. The paper provides both brief theoretical justifications and a complete technical description of the crypto algorithm.

*Keywords:* cryptography, VOMF technique, stream cipher, cryptographic algorithm, special encryption technique, information security.

*GJRE-J Classification:* DDC Code: 005.1 LCC Code: QA76.6



*Strictly as per the compliance and regulations of:*



RESEARCH | DIVERSITY | ETHICS

# New Encryption Algorithm with Improved Security

Dmitriy Shatokhin

**Abstract-** The design of new cryptographic algorithms, as a rule, has the main goal of improving their resistance to cryptanalysis methods. Since cryptanalysis methods are constantly being improved, when designing crypto algorithms, it becomes necessary to create new non-standard approaches that can effectively resist the existing cryptanalysis methods. This paper describes in detail a new crypto algorithm created using an original technique aimed at radically improving cryptographic strength. The paper provides both brief theoretical justifications and a complete technical description of the crypto algorithm.

**Keywords:** cryptography, VOMF technique, stream cipher, cryptographic algorithm, special encryption technique, information security.

## I. INTRODUCTION

One of the fundamental principles of cryptography is that a cryptanalyst's detailed knowledge of a crypto algorithm should not affect the security of the cryptosystem in any way. All existing methods of cryptanalysis are based, one way or another, on a detailed knowledge of the operation of the crypto algorithm under study. It follows that if one somehow limits or reduces the knowledge of the cryptanalyst about the work of at least some important part of the algorithm used, then the cryptanalysis of such a crypto algorithm will turn out to be much more difficult. An example of such an approach is a periodic change in the program code of the encryption function of the crypto algorithm, and such a change should be unpredictable for the cryptanalyst - in particular, it can be based on the encryption key. That is, in other words, the program code of the encryption function of the algorithm (or several functions) is not unchanged and initially defined - instead, during execution it is either replaced by an alternative code from a predetermined large set of functions, or is formed as the algorithm works. On this principle, a special technique for constructing crypto algorithms with increased security is based [1].

This paper describes in detail the synchronous streaming crypto algorithm IMPASE (IMProved Algorithm of Stream Encryption), which is one of the practical examples of the use of a special technique [1],

which provides for the presence of a variable program code of the encryption function.

## II. ABBREVIATIONS AND SYMBOLS USED

**KSA:** (Key Scheduling Algorithm) is a preliminary procedure for preparing data structures and working variables of the main crypto algorithm based on the encryption key. It precedes the work of the main crypto algorithm.

**VOMF:** (**VO**latile **MA**in **F**unction) is a special technique for designing crypto algorithms, which provides for the creation of an encryption function (or functions) that changes according to some rules in a crypto algorithm.

**IV:** Is the initialization vector. A non-secret value sent along with the encrypted message for initialization.

**+**: arithmetic modulo addition. When adding byte values, the addition is performed modulo 256. When adding 32-bit words, it is performed, respectively, modulo  $2^{32}$ .

**\***: arithmetic multiplication modulo  $2^{32}$ .

**<<<n:** cyclic shift of a 32-bit word by n bits to the left.

**>>>n:** cyclic shift of a 32-bit word by n bits to the right.

**<<n:** logical shift of a 32-bit word by n bits to the left. The bits that are pushed into the vacated space are always 0.

**>>n:** is a logical shift of a 32-bit word by n bits to the right. The bits that are pushed into the vacated space are always 0.

**&:** is a bitwise AND operation.

**OR:** is a bitwise OR operation.

**XOR:** is a bitwise XOR operation.

**||:** is the operation of concatenation (connection) of 4 separate bytes into one 32-bit word.

**< >:** is the operation of splitting one 32-bit word into 4 separate bytes.

**×:** is a generic term for some non-linear operation performed on two 32-bit words.

**w2b(W):** (Word-to-Byte) is a function to convert a 32-bit word *W* to a byte. The conversion is performed by adding together all four bytes of the word *W* modulo 256. The resulting sum of 1 byte is the result of the function.

**Author:** "TechnoCrypt" Research Group, Chief of "TechnoCrypt" Research Group, Karaganda City, Kazakhstan Republic.  
e-mails: dvsh68@mail.ru, techno1crypt@gmail.com

All illustrative code fragments in this work are written in the standard C language. Hexadecimal numbers are also given in the C format.

### III. ABOUT THE VOMF TECHNIQUE IN THE IMPASE ALGORITHM

As mentioned above, the use of the VOMF technique in the crypto algorithm design is carried out in order to significantly complicate its cryptanalysis. In the general case, for this, the program code of the crypto algorithm provides for one or more changing (volatile) functions that perform data transformation, and which can replace each other in some pseudo-random way. Such volatile functions can either be predefined or created in some way during the execution of the algorithm. In other words, in addition to the uncertainty of key data that is unknown to the cryptanalyst, it is also necessary to increase the degree of uncertainty of the operations performed on this data. There are many practical ways to do this, and the IMPASE crypto algorithm demonstrates just one possible way to use this technique.

#### a) Volatile Function

The IMPASE crypto algorithm uses a three-argument volatile function with a common prototype as follows:

$$F(A, B, C) = A \times B \times C \quad (1)$$

where A, B, and C are 32-bit words, and the sign " $\times$ " denotes some non-linear operation assigned during execution on 32-bit words. Operations are performed sequentially from left to right, that is, first the operation is performed with arguments A and B, and then – the result of execution with argument C. The order of the arguments can be any, that is, F(A,B,C), F(B,C,A), F(C,B,A), etc. Since there are three arguments, the number of their possible permutations is 3!, that is, 6. The effective order of the arguments when executing the algorithm is determined when executing the key scheduling algorithm (KSA), and is unchanged for the current combination of encryption key and initialization vector.

For this function, 8 special composite non-linear operations have been developed, each of which, as shown in (1), performs a transformation on two 32-bit words, and the result of its execution is one 32-bit word. Before calling the function, 2 operations out of 8 possible are selected in a pseudo-random way. It is easy to show that the number of options for choosing 2 different elements out of 8 possible (taking into account the permutations of these 2 elements) is 56, plus 8 more options in the case of identical elements. Then the total number of options is 64. Given that the result of the function depends both on the order of the operands and on the selected operations, the total number of possible results is  $64 * 6 = 384$ . That is, in other words, 384

variants of the volatile function are possible. All these options somehow depend only on the combination of the encryption key and the initialization vector, and, as was said, the order of the operands is determined during the execution of the KSA, and the operations are selected before the function call, depending on the state of the internal parameters of the algorithm.

An important detail to note is that all these non-linear operations are designed so that they have the same execution time. It is necessary mainly to make runtime cryptanalysis inefficient. This type of cryptanalysis is based on the exact measurement of the execution time of individual sections of the program code of the crypto algorithm. And although in real practical conditions this type of cryptanalysis is very difficult, nevertheless, its possibility must be taken into account.

Creating nonlinear operations with the same execution time is a rather complicated practical problem, and in this algorithm it is solved due to the fact that on most microprocessors, the operations of register cyclic shift, logical register shift, addition, OR and XOR operations are performed in the same number of microprocessor cycles. By combining these operations in a certain way, it is possible to achieve both a good degree of nonlinearity of the result and the same execution time for these composite operations. The following section provides a detailed description of these operations.

#### b) Nonlinear Operations in the Algorithm

The IMPASE crypto algorithm uses 8 non-linear operations performed in the volatile function described above. The following description of these operations assumes that they are performed on operands A and B. Each operation also uses a 1-byte auxiliary variable  $t$  to store the result of  $w2b$  (see Section II), and then truncates  $t$  to the lowest significant 5 bits.

##### 1. Operation *LrotXor* (Left Rotate and XOR)

Usage: *LrotXor*(A,B)

$t = w2b(B) \& 0x1F;$

$LrotXor = (A \ll \langle t \rangle) \text{ XOR } (B \gg (32-t));$

##### 2. Operation *LrotAdd* (Left Rotate and Addition)

Usage: *LrotAdd*(A,B)

$t = w2b(B) \& 0x1F;$

$LrotAdd = (A \ll \langle t \rangle) + (B \ll (32-t));$

##### 3. Operation *LshOr* (Left Shift and OR)

Usage: *LshOr*(A,B)

$t = w2b(B) \& 0x1F;$

$LshOr = (A \ll \langle t \rangle) \text{ OR } (B \gg (32-t));$

##### 4. Operation *LshAdd* (Left Shift and Addition)

Usage: *LshAdd*(A,B)

$t = w2b(B) \& 0x1F;$

$LshAdd = (A \ll \langle t \rangle) + (B \ll \langle t \rangle);$

##### 5. Operation *RrotXor* (Right Rotate and XOR)

Usage: *RrotXor*(A,B)

$t = w2b(B) \& 0x1F;$

$RrotXor = (A \gg \langle t \rangle) \text{ XOR } (B \ll (32-t));$

6. Operation *RrotAdd* (Right Rotate and Addition)Usage: *RrotAdd*(A,B) $t = w2b(B) \& 0x1F;$  $RrotAdd = (A \gg t) \text{ XOR } (B \gg (32-t));$ 7. Operation *RshOr* (Right Shift and OR)Usage: *RshOr*(A,B) $t = w2b(B) \& 0x1F;$  $RshOr = (A \gg t) \text{ OR } (B \ll (32-t));$ 8. Operation *RshAdd* (Right Shift and Addition)Usage: *RshAdd*(A,B) $t = w2b(B) \& 0x1F;$  $RshAdd = (A \gg (32-t)) + (B \gg t);$ 

In the IMPASE crypto algorithm, these operations are numbered from 0 to 7. It should be noted that when programming the algorithm, it is advisable to create an array of pointers to functions that perform these operations, and subsequently call these functions by the number of the array element.

#### IV. DESCRIPTION OF THE IMPASE ALGORITHM

Strictly speaking, the IMPASE crypto algorithm is not a separate algorithm - it is a whole family of algorithms, since by changing a number of its parameters, you can get many other similar algorithms with different characteristics. These options are described in more detail in the next section. The following is a description of the basic version of the algorithm.

##### a) General Characteristics

The IMPASE crypto algorithm is a synchronous stream encryption algorithm that generates one pseudo-random 32-bit word in one cycle of its work. This algorithm is designed primarily for software implementation, but it can also be used in specialized controllers. Being a synchronous stream cipher algorithm, it is actually a generator of a pseudo-random cryptographic sequence ( $\gamma$ ) with a very large period. The sequence obtained as a result of its work can be superimposed on the open data - as a rule, using the "exclusive OR" operation. Thus, the cryptographic strength of such a system is entirely determined by the cryptographic strength of the generated sequence. The following are its main characteristics:

- algorithm type: synchronous stream cipher;
- encryption key size: 384 bits;
- initialization vector size: 32 bits;
- required amount of memory for internal data: about 2.5 kilobytes;
- predefined data and constants: not used;
- output data: crypto-resistant pseudo-random sequence;
- output sequence element: 32-bit word.

Some other properties and features of this algorithm - such as the period of the output pseudo-random sequence, its statistical characteristics, the speed of the algorithm - are described in the next section.

##### b) Key Scheduling Algorithm (KSA)

This auxiliary algorithm prepares the internal data of the crypto algorithm based on the encryption key and initialization vector. The encryption key, as shown above, has a size of 384 bits and is considered as a sequence of 8-bit blocks, i.e. bytes. All operations with the encryption key, as well as the initialization vector, are performed at the level of an integer number of bytes. Thus, the encryption key must be 48 bytes in size. The initialization vector, respectively, has a size of 4 bytes.

For the operation of the main crypto algorithm, KSA prepares 4 data blocks, which are called S-block (Substitution block), P-block (Parameters block), M-block (Master block) and C-block (Control block). These blocks have the following structure:

- The S-block is 8 byte arrays of 256 bytes each. Each of these arrays contains a permutation of numbers from 0 to 255, thus being a bijection of an ordered array with values from 0 to 255. The permutation in each of the 8 arrays is individual and does not depend on other arrays;
- P-block is a byte array of 259 bytes. During operation, 4 consecutive bytes are extracted from it, interpreted as one 32-bit word;
- M-block is an array of 8 32-bit words;
- C-block is a 4-byte byte array.

When KSA is working, the following operations are strictly sequential:

1. *Formation of the C-block.* To form a C-block (this is an array of 4 bytes), the first 4 bytes of the encryption key are copied into this array.
2. *Formation of the M-block and its copy.* To form an M-block (this is an array of 8 32-bit words), the last 32 bytes of the key are copied into this array, forming 8 32-bit words, since each 32-bit word occupies 4 bytes. Then a copy of the M-block is created - the same array of 8 32-bit words, further referred to as *Mcopy* in the description. It will take part in further KSA operations.
3. *Creation of a shift register with non-linear feedback.* To form the remaining blocks, a byte shift register with non-linear feedback is first created, which will be used as a generator of pseudo-random bytes. The operation scheme of such a register is shown in Fig.1. To do this, the first 16 bytes of the key are copied into a separate 16-byte array *Reg*, and then in this array the first 4 bytes are replaced by 4 bytes of the initialization vector. Further, the array *Reg* is used as a shift register with non-linear feedback. To implement the feedback mechanism, the previously



created *Mcopy* array of 8 32-bit words is used. A primitive feedback polynomial of the 16th degree as follows is also used:

$$P(X) = X^{16} + X^5 + X^4 + X^3 + 1 \quad (2)$$

In general, the operation of such a register is almost similar to the operation of classical registers with linear feedback in the Galois configuration [2], with the difference that it uses not a bit array, but a byte array, as well as nonlinear feedback with some features. More details about the operation of shift registers can also be found in [3].

It must be said that the creation and properties of non-linear feedback shift registers is a topic for a separate article, but here it is only important to note that the shift register described above generates a

statistically good pseudo-random byte sequence with a very large period.

Initially, after creating this register, 128 "idle" generation cycles are performed - this is necessary for mixing the bits of the key and the initialization vector. Further, this shift register is used as a generator of pseudo-random bytes to create the following blocks.

4. *Formation of the S-block.* To form an S-block, each of the 8 256 byte arrays is first filled with ordered values from 0 to 255. Then the array is shuffled using a pseudo-random sequence obtained from the shift register described above. The following C program fragment illustrates this process. The `nextbyte()` function is supposed to return the next pseudo-random byte from the register. You also need to remember that in C, arrays are numbered from zero:

```
typedef unsigned char byte;

int i,j;

byte sblock[8][256];

byte t,n;

for(i=0;i<8;i++)
    for(j=0;j<256;j++) sblock[i][j]=j; //filling from 0 to 255

for(i=0;i<8;i++) {
    n=0;
    for(j=0;j<256;j++) { //mixing
        n+=nextbyte(); t=sblock[i][j];
        sblock[i][j]=sblock[i][n]; sblock[i][n]=t;
    }
    for(j=255;j>=0;j--) {
        n+=nextbyte(); t=sblock[i][j];
        sblock[i][j]=sblock[i][n]; sblock[i][n]=t;
    }
}
```

As it follows from this example, shuffling is carried out in two passes - first in the forward direction and then vice versa. After that, the formation of the S-block is over - now all 8 arrays are shuffled independently of each other.

5. *Formation of the P-block.* To form a P-block, the corresponding array of 259 bytes is filled with the next pseudo-random bytes from the register.
6. *Determination of operand indexes for volatile function.* This step determines the order of the operands when the function is called. To do this, three-byte variables are used as indexes - *ix0*, *ix1*

and  $ix2$ . An array of 3 32-bit words  $Opers$ , is also created to store the operands of the volatile function. Subsequently, these byte variables will be used in the main cycle of the algorithm as indexes

```

typedef unsigned char byte;

byte n, ix0, ix1, ix2

n=nextbyte();

ix0=n%3; //ix0 = n mod 3;

if(n>>7) { //if highest bit = 1

    ix1=(ix0+1)%3; ix2=(ix1+1)%3;

} else { //if highest bit = 0

    ix2=(ix0+1)%3; ix1=(ix2+1)%3;

}

```

As a result, these variables get the values 0, 1, and 2 in some sequence determined by the pseudo-random byte. In this way, the order of the operands is determined. This order is further used in the main cycle of the algorithm.

#### c) Main Cycle of the Algorithm

The main cycle of the IMPASE crypto algorithm consists of two steps. The first step is to extract the next data from the blocks and calculate an intermediate value based on them, and this calculation is performed using a volatile function. The second step is to generate a 32-bit output value and modify the data blocks. During the operation of the main cycle, the algorithm actively uses the operation of concatenation of 4 separate bytes into a 32-bit word, and the reverse operation - the separation of a 32-bit word into 4 separate bytes.

1. *The first step of the main cycle.* The scheme of the first step is shown in Fig.2. The following actions are performed:

- 4 consecutive bytes are extracted from the P-block, starting from the position determined by the first byte of the C-block, i.e. the first byte of the C-block is an index to retrieve the bytes from the P-block. The extracted bytes are concatenated into a 32-bit word and stored as an element of the  $Opers[ix2]$  array.
- similarly, 4 more consecutive bytes are extracted from the P-block, starting from the position determined by the second byte of the C-block. The extracted bytes are also concatenated into a 32-bit word and stored in the 32-bit  $Param1$  variable.
- a 32-bit word is extracted from the M-block, while the three highest bits of the third byte of the C-block

of the  $Opers$  array. To initialize these variables, the next pseudo-random byte is first generated from the register, and then the following calculations are performed:

- are used as an index. This word is stored as an element of the  $Opers[ix1]$  array.
  - A 32-bit word is extracted from the S-block as follows: the lowest three bits of the third byte of the C-block are used as the number of the 256-byte array (from 0 to 7). As an index inside the selected array, the fourth byte of the C-block is used with the two lowest bits previously set to zero - this is done to prevent possible overflow of the array. Starting from this index, 4 consecutive bytes are extracted from the array, concatenated into a 32-bit word, then the resulting word is added modulo  $2^{32}$  to the  $Param1$  variable, and the result is stored as an element of the  $Opers[ix0]$  array.
  - the lowest three bits of the first byte of the C-block are stored in the variable  $Op1$ . This is the number of the first non-linear operation for a volatile function.
  - the lowest three bits of the second byte of the C-block are stored in the variable  $Op2$ . This is the number of the second non-linear operation for a volatile function.
  - a volatile function of the form (1) is called, while the three operands of this function are stored as elements of the  $Opers$  array, and the numbers of non-linear operations are stored in the variables  $Op1$  and  $Op2$ . First, the operation is performed on the elements  $Oper[0]$  and  $Oper[1]$ , and then on the result and the element  $Oper[2]$ . The final result of the calculation is one 32-bit word. It is stored in the  $Temp$  variable and used further in the second step of the main cycle.
2. *The second step of the main cycle.* The scheme of the second step is shown in Fig.3. The following actions are performed:

- separate bytes are extracted from the S-block as follows. The 32-bit variables *Param1* and *Temp* are separated by 4 bytes each. The lowest three bits of each byte of the *Param1* variable serve as the numbers (0..7) of the 4 arrays in the S-block, and each of the 4 bytes of the *Temp* variable is an index (0..255) for extracting a byte from the corresponding array. For example, if the lowest three bits of each of the 4 bytes of the *Param1* variable are equal to 4,5,0 and 7, and the four bytes of the *Temp* variable are equal to 95,144,67 and 201, respectively, then a byte will be extracted from the 4th S-block array by index 95, from the 5th array - byte at index 144, from the 0th array - byte at index 67, and from the 7th array - byte at index 201. The 4 bytes obtained in this way are concatenated into a 32-bit value, which is the output 32-bit word of the algorithm.
  - P-block is modified. To do this, those 4 bytes of the P-block that were used in the first step, and position of which was determined by the first byte of the C-block, are interpreted as a 32-bit word. This word is added modulo  $2^{32}$  to the *Temp* variable (which stores the result of evaluating the volatile function).
  - M-block is modified. To do this, the element of the array that was selected at the first step (its index is determined as the value of the three highest bits of the third byte of the C-block) is added modulo  $2^{32}$  to the *Param1* variable.
  - C-block is modified. To do this, 4 bytes of the C-block are concatenated into a 32-bit word, which is added modulo  $2^{32}$  to the array element *Opers[ix0]* (this array element, as described above, stores the 32-bit word extracted from the S-block, added to the *Param1* variable).
- This completes the main cycle of the algorithm. To generate the next word, the main cycle of the algorithm is repeated. From the description of the main cycle, it can be seen that when generating the output 32-bit word, the algorithm performs a double non-linear transformation: the first is for non-linear operations of calculating an intermediate value, which is performed by a volatile function, and the second is for fetching output bytes from the S-block, which is actually a non-linear replacement operation.

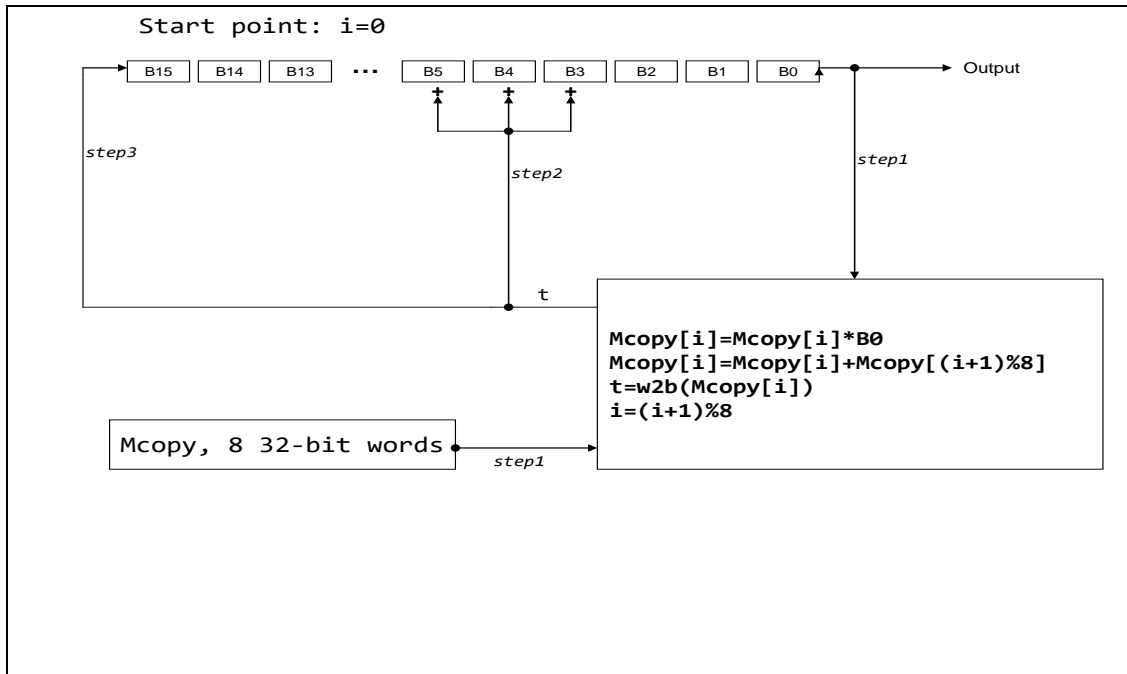

Figure 1: Scheme of Non-linear Feedback Shift Register

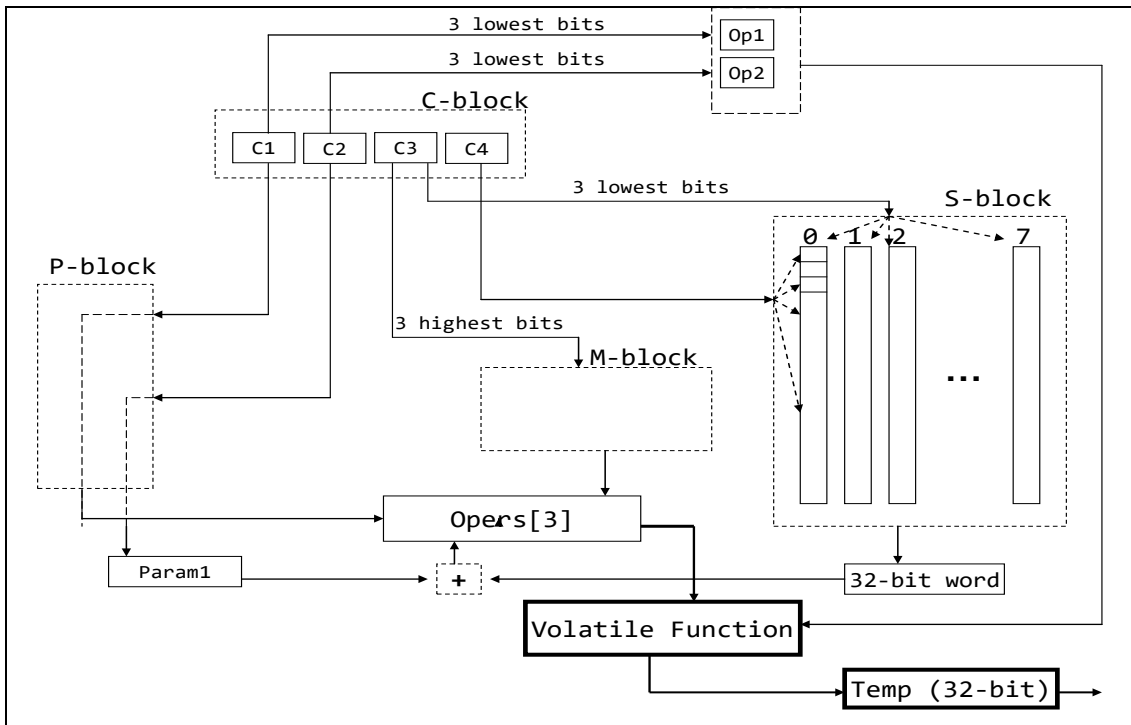

Figure 2: Scheme of the First Step of Main Cycle

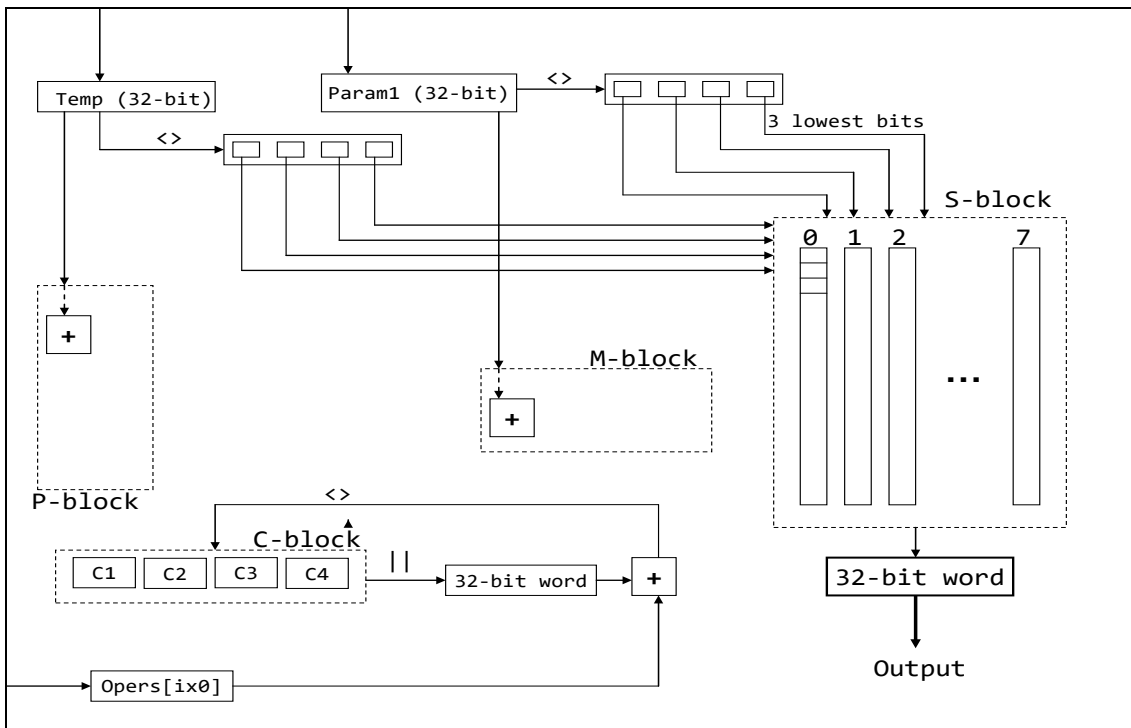

Figure 3: Scheme of the Second Step of Main Cycle

## V. PROPERTIES OF THE IMPASE ALGORITHM

### a) Statistical Properties of the Generated Sequence

A necessary condition for the operation of any stream crypto algorithm is, in addition to cryptographic strength, good statistical characteristics of the generated pseudo-random sequence. For the IMPASE algorithm, the statistical analysis of the generated

sequence was performed in accordance with the recommended set of statistical tests for pseudorandom sequences [4]. For testing, 16384 32-bit words were generated, which in total is 64 kilobytes.

It should be noted that, as in most crypto algorithms, in IMPASE changing at least one bit of the encryption key or initialization vector leads to a complete

change in the entire generated sequence, since (as described above) leads to a complete change in the results of the shift register and, accordingly, to a complete change in at least the S-block and P-block. Therefore, statistical tests were carried out for 50 different, completely random, encryption keys and initialization vectors. In all cases, very good test results were obtained.

#### b) *Crypto Algorithm Performance*

The pseudo-random sequence generation speed was evaluated on an Intel Core i3 processor with a clock frequency of 3.0 Mhz, on the core of the MS-DOS operating system. This operating system was chosen due to the fact that, due to the absence of third-party processes, the maximum performance of iterative algorithms is achieved on it (unlike Windows and Linux OS). In addition, the MS-DOS kernel is often used in specialized controllers. To evaluate the performance, the algorithm was implemented in the C language, and the Watcom C v9.5a optimizing compiler was used to compile the program. All possible optimizations were made, both at the level of the program code and in the compiler settings. For comparison, we measured the performance of the RC4 algorithms, as well as AES (10 rounds, OFB mode) under the same conditions. The RC4 algorithm was chosen for comparison because it is one of the fastest stream crypto algorithms, and the AES algorithm because it is the current standard. The IMPASE algorithm had a generation rate of 940 Mbps, while the RC4 algorithm had 2200 Mbps, and the AES algorithm had 180 Mbps. It can be assumed that when the algorithm is implemented in the Assembler language, the performance can be significantly improved.

#### c) *Possible Algorithm Modifications*

As noted above, the IMPASE algorithm is actually a whole family of algorithms. By changing a number of its parameters, one can obtain crypto algorithms with other properties. The following are the parameters that can significantly affect the properties of the generated sequence:

- the number of arrays in the S-block. Increasing the number of arrays will lead to even more cryptographic strength, but will require more memory to work with, and increase the KSA running time. In the described basic version, the S-block contains 8 arrays and, according to our estimates, this is the minimum required number.
- increasing in the number of non-linear operations for a volatile function. Such an increase will also increase cryptographic strength, since it will lead to an increase in the number of options for a volatile function. However, it must be remembered that the operations must have a high degree of non-linearity,

and also have the same execution time - this is the most difficult condition.

- increasing the number of operands in a non-constant function. Such an increase will also increase cryptographic strength, however, it will lead to an increase in the generation time of the output value and, accordingly, to an increase in the generation time of the entire sequence.
- changing the way data blocks are generated. Instead of the existing non-linear feedback shift register, a simpler and faster way to populate and shuffle algorithm data blocks can be designed. This may lead to a simplification of the KSA. However, it must be remembered that the algorithm for preparing data blocks should not contain easily traceable linear dependencies - this can lead to a noticeable drop in the cryptographic strength of the entire algorithm.

## VI. CONCLUSION

This paper describes in detail a method for creating cryptographic algorithms with increased cryptographic strength based on the VOMF technique, and also describes in detail the IMPASE stream crypto algorithm created using this technique, and which is a practical example of its use. It should be noted that the implementation of this technique in the IMPASE algorithm is very simple and intuitive. However, this is only one of the possible ways to apply the VOMF technique - there are many other, more complex ways. In addition, a similar approach can be very successfully implemented also in the design of block crypto algorithms - at present, we are completing tests of a block crypto algorithm built using the same technique.

We hope that this work will be useful for understanding the aspects of improving cryptographic strength in the design and analysis of cryptographic algorithms.

## REFERENCES RÉFÉRENCES REFERENCIAS

1. [https://web.archive.org/web/20180411172542id\\_/https://www.fruct.org/publications/abstract20/files/Sha.pdf](https://web.archive.org/web/20180411172542id_/https://www.fruct.org/publications/abstract20/files/Sha.pdf).
2. [https://en.wikipedia.org/wiki/Linear-feedback\\_shift\\_register](https://en.wikipedia.org/wiki/Linear-feedback_shift_register).
3. B. Schneier, *Applied cryptography*. Second edition. John Wiley & Sons. 1996.
4. Donald E. Knuth, *The Art of Computer Programming*. Vol. 2: Seminumerical Algorithms (3rd ed.). Addison-Wesley Professional. ISBN 978-0-201-89684-8.

# GLOBAL JOURNALS GUIDELINES HANDBOOK 2023

---

[WWW.GLOBALJOURNALS.ORG](http://WWW.GLOBALJOURNALS.ORG)

# MEMBERSHIPS

## FELLOWS/ASSOCIATES OF ENGINEERING RESEARCH COUNCIL

### FERC/AERC MEMBERSHIPS

#### INTRODUCTION



FERC/AERC is the most prestigious membership of Global Journals accredited by Open Association of Research Society, U.S.A (OARS). The credentials of Fellow and Associate designations signify that the researcher has gained the knowledge of the fundamental and high-level concepts, and is a subject matter expert, proficient in an expertise course covering the professional code of conduct, and follows recognized standards of practice. The credentials are designated only to the researchers, scientists, and professionals that have been selected by a rigorous process by our Editorial Board and Management Board.

Associates of FERC/AERC are scientists and researchers from around the world are working on projects/researches that have huge potentials. Members support Global Journals' mission to advance technology for humanity and the profession.

## FERC

### FELLOW OF ENGINEERING RESEARCH COUNCIL

FELLOW OF ENGINEERING RESEARCH COUNCIL is the most prestigious membership of Global Journals. It is an award and membership granted to individuals that the Open Association of Research Society judges to have made a 'substantial contribution to the improvement of computer science, technology, and electronics engineering.

The primary objective is to recognize the leaders in research and scientific fields of the current era with a global perspective and to create a channel between them and other researchers for better exposure and knowledge sharing. Members are most eminent scientists, engineers, and technologists from all across the world. Fellows are elected for life through a peer review process on the basis of excellence in the respective domain. There is no limit on the number of new nominations made in any year. Each year, the Open Association of Research Society elect up to 12 new Fellow Members.



## BENEFIT

### TO THE INSTITUTION

#### GET LETTER OF APPRECIATION

Global Journals sends a letter of appreciation of author to the Dean or CEO of the University or Company of which author is a part, signed by editor in chief or chief author.



### EXCLUSIVE NETWORK

#### GET ACCESS TO A CLOSED NETWORK

A FERC member gets access to a closed network of Tier 1 researchers and scientists with direct communication channel through our website. Fellows can reach out to other members or researchers directly. They should also be open to reaching out by other.

Career

Credibility

Exclusive

Reputation



### CERTIFICATE

#### CERTIFICATE, LOR AND LASER-MOMENTO

Fellows receive a printed copy of a certificate signed by our Chief Author that may be used for academic purposes and a personal recommendation letter to the dean of member's university.

Career

Credibility

Exclusive

Reputation



### DESIGNATION

#### GET HONORED TITLE OF MEMBERSHIP

Fellows can use the honored title of membership. The "FERC" is an honored title which is accorded to a person's name viz. Dr. John E. Hall, Ph.D., FERC or William Walldroff, M.S., FERC.

Career

Credibility

Exclusive

Reputation

### RECOGNITION ON THE PLATFORM

#### BETTER VISIBILITY AND CITATION

All the Fellow members of FERC get a badge of "Leading Member of Global Journals" on the Research Community that distinguishes them from others. Additionally, the profile is also partially maintained by our team for better visibility and citation. All fellows get a dedicated page on the website with their biography.

Career

Credibility

Reputation



## FUTURE WORK

### GET DISCOUNTS ON THE FUTURE PUBLICATIONS

Fellows receive discounts on the future publications with Global Journals up to 60%. Through our recommendation programs, members also receive discounts on publications made with OARS affiliated organizations.

Career

Financial

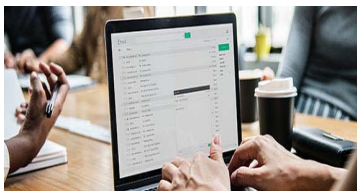

## GJ ACCOUNT

### UNLIMITED FORWARD OF EMAILS

Fellows get secure and fast GJ work emails with unlimited storage of emails that they may use them as their primary email. For example, john [AT] globaljournals [DOT] org.

Career

Credibility

Reputation



## PREMIUM TOOLS

### ACCESS TO ALL THE PREMIUM TOOLS

To take future researches to the zenith, fellows receive access to all the premium tools that Global Journals have to offer along with the partnership with some of the best marketing leading tools out there.

Financial

## CONFERENCES & EVENTS

### ORGANIZE SEMINAR/CONFERENCE

Fellows are authorized to organize symposium/seminar/conference on behalf of Global Journal Incorporation (USA). They can also participate in the same organized by another institution as representative of Global Journal. In both the cases, it is mandatory for him to discuss with us and obtain our consent. Additionally, they get free research conferences (and others) alerts.

Career

Credibility

Financial

## EARLY INVITATIONS

### EARLY INVITATIONS TO ALL THE SYMPOSIUMS, SEMINARS, CONFERENCES

All fellows receive the early invitations to all the symposiums, seminars, conferences and webinars hosted by Global Journals in their subject.

Exclusive





## PUBLISHING ARTICLES & BOOKS

### EARN 60% OF SALES PROCEEDS

Fellows can publish articles (limited) without any fees. Also, they can earn up to 70% of sales proceeds from the sale of reference/review books/literature/publishing of research paper. The FERC member can decide its price and we can help in making the right decision.

Exclusive Financial

## REVIEWERS

### GET A REMUNERATION OF 15% OF AUTHOR FEES

Fellow members are eligible to join as a paid peer reviewer at Global Journals Incorporation (USA) and can get a remuneration of 15% of author fees, taken from the author of a respective paper.

Financial

## ACCESS TO EDITORIAL BOARD

### BECOME A MEMBER OF THE EDITORIAL BOARD

Fellows may join as a member of the Editorial Board of Global Journals Incorporation (USA) after successful completion of three years as Fellow and as Peer Reviewer. Additionally, Fellows get a chance to nominate other members for Editorial Board.

Career Credibility Exclusive Reputation

## AND MUCH MORE

### GET ACCESS TO SCIENTIFIC MUSEUMS AND OBSERVATORIES ACROSS THE GLOBE

All members get access to 5 selected scientific museums and observatories across the globe. All researches published with Global Journals will be kept under deep archival facilities across regions for future protections and disaster recovery. They get 10 GB free secure cloud access for storing research files.



## ASSOCIATE OF ENGINEERING RESEARCH COUNCIL

ASSOCIATE OF ENGINEERING RESEARCH COUNCIL is the membership of Global Journals awarded to individuals that the Open Association of Research Society judges to have made a 'substantial contribution to the improvement of computer science, technology, and electronics engineering.

The primary objective is to recognize the leaders in research and scientific fields of the current era with a global perspective and to create a channel between them and other researchers for better exposure and knowledge sharing. Members are most eminent scientists, engineers, and technologists from all across the world. Associate membership can later be promoted to Fellow Membership. Associates are elected for life through a peer review process on the basis of excellence in the respective domain. There is no limit on the number of new nominations made in any year. Each year, the Open Association of Research Society elect up to 12 new Associate Members.



## BENEFIT

### TO THE INSTITUTION

#### GET LETTER OF APPRECIATION

Global Journals sends a letter of appreciation of author to the Dean or CEO of the University or Company of which author is a part, signed by editor in chief or chief author.



### EXCLUSIVE NETWORK

#### GET ACCESS TO A CLOSED NETWORK

A AERC member gets access to a closed network of Tier 1 researchers and scientists with direct communication channel through our website. Associates can reach out to other members or researchers directly. They should also be open to reaching out by other.

Career

Credibility

Exclusive

Reputation



### CERTIFICATE

#### CERTIFICATE, LOR AND LASER-MOMENTO

Associates receive a printed copy of a certificate signed by our Chief Author that may be used for academic purposes and a personal recommendation letter to the dean of member's university.

Career

Credibility

Exclusive

Reputation



### DESIGNATION

#### GET HONORED TITLE OF MEMBERSHIP

Associates can use the honored title of membership. The "AERC" is an honored title which is accorded to a person's name viz. Dr. John E. Hall, Ph.D., AERC or William Walldroff, M.S., AERC.

Career

Credibility

Exclusive

Reputation

### RECOGNITION ON THE PLATFORM

#### BETTER VISIBILITY AND CITATION

All the Associate members of AERC get a badge of "Leading Member of Global Journals" on the Research Community that distinguishes them from others. Additionally, the profile is also partially maintained by our team for better visibility and citation. All associates get a dedicated page on the website with their biography.

Career

Credibility

Reputation

## FUTURE WORK

### GET DISCOUNTS ON THE FUTURE PUBLICATIONS

Associates receive discounts on the future publications with Global Journals up to 60%. Through our recommendation programs, members also receive discounts on publications made with OARS affiliated organizations.

Career

Financial

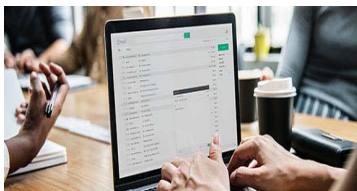

## GJ ACCOUNT

### UNLIMITED FORWARD OF EMAILS

Associates get secure and fast GJ work emails with unlimited storage of emails that they may use them as their primary email. For example, john [AT] globaljournals [DOT] org..

Career

Credibility

Reputation



## PREMIUM TOOLS

### ACCESS TO ALL THE PREMIUM TOOLS

To take future researches to the zenith, associates receive access to all the premium tools that Global Journals have to offer along with the partnership with some of the best marketing leading tools out there.

Financial

## CONFERENCES & EVENTS

### ORGANIZE SEMINAR/CONFERENCE

Associates are authorized to organize symposium/seminar/conference on behalf of Global Journal Incorporation (USA). They can also participate in the same organized by another institution as representative of Global Journal. In both the cases, it is mandatory for him to discuss with us and obtain our consent. Additionally, they get free research conferences (and others) alerts.

Career

Credibility

Financial

## EARLY INVITATIONS

### EARLY INVITATIONS TO ALL THE SYMPOSIUMS, SEMINARS, CONFERENCES

All associates receive the early invitations to all the symposiums, seminars, conferences and webinars hosted by Global Journals in their subject.

Exclusive





## PUBLISHING ARTICLES & BOOKS

### EARN 30-40% OF SALES PROCEEDS

Associates can publish articles (limited) without any fees. Also, they can earn up to 30-40% of sales proceeds from the sale of reference/review books/literature/publishing of research paper.

Exclusive

Financial

## REVIEWERS

### GET A REMUNERATION OF 15% OF AUTHOR FEES

Associate members are eligible to join as a paid peer reviewer at Global Journals Incorporation (USA) and can get a remuneration of 15% of author fees, taken from the author of a respective paper.

Financial

## AND MUCH MORE

### GET ACCESS TO SCIENTIFIC MUSEUMS AND OBSERVATORIES ACROSS THE GLOBE

All members get access to 2 selected scientific museums and observatories across the globe. All researches published with Global Journals will be kept under deep archival facilities across regions for future protections and disaster recovery. They get 5 GB free secure cloud access for storing research files.

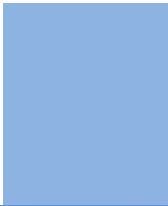

ASSOCIATE	FELLOW	RESEARCH GROUP	BASIC
<p>\$4800 lifetime designation</p> <hr/> <p>Certificate, LoR and Momento 2 discounted publishing/year Gradation of Research 10 research contacts/day 1 GB Cloud Storage GJ Community Access</p>	<p>\$6800 lifetime designation</p> <hr/> <p>Certificate, LoR and Momento Unlimited discounted publishing/year Gradation of Research Unlimited research contacts/day 5 GB Cloud Storage Online Presense Assistance GJ Community Access</p>	<p>\$12500.00 organizational</p> <hr/> <p>Certificates, LoRs and Momentos Unlimited free publishing/year Gradation of Research Unlimited research contacts/day Unlimited Cloud Storage Online Presense Assistance GJ Community Access</p>	<p>APC per article</p> <hr/> <p>GJ Community Access</p>



## PREFERRED AUTHOR GUIDELINES

---

### **We accept the manuscript submissions in any standard (generic) format.**

We typeset manuscripts using advanced typesetting tools like Adobe In Design, CorelDraw, TeXnicCenter, and TeXStudio. We usually recommend authors submit their research using any standard format they are comfortable with, and let Global Journals do the rest.

Alternatively, you can download our basic template from <https://globaljournals.org/Template.zip>

Authors should submit their complete paper/article, including text illustrations, graphics, conclusions, artwork, and tables. Authors who are not able to submit manuscript using the form above can email the manuscript department at [submit@globaljournals.org](mailto:submit@globaljournals.org) or get in touch with [chiefeditor@globaljournals.org](mailto:chiefeditor@globaljournals.org) if they wish to send the abstract before submission.

### BEFORE AND DURING SUBMISSION

Authors must ensure the information provided during the submission of a paper is authentic. Please go through the following checklist before submitting:

1. Authors must go through the complete author guideline and understand and *agree to Global Journals' ethics and code of conduct*, along with author responsibilities.
2. Authors must accept the privacy policy, terms, and conditions of Global Journals.
3. Ensure corresponding author's email address and postal address are accurate and reachable.
4. Manuscript to be submitted must include keywords, an abstract, a paper title, co-author(s) names and details (email address, name, phone number, and institution), figures and illustrations in vector format including appropriate captions, tables, including titles and footnotes, a conclusion, results, acknowledgments and references.
5. Authors should submit paper in a ZIP archive if any supplementary files are required along with the paper.
6. Proper permissions must be acquired for the use of any copyrighted material.
7. Manuscript submitted *must not have been submitted or published elsewhere* and all authors must be aware of the submission.

### Declaration of Conflicts of Interest

It is required for authors to declare all financial, institutional, and personal relationships with other individuals and organizations that could influence (bias) their research.

### POLICY ON PLAGIARISM

Plagiarism is not acceptable in Global Journals submissions at all.

Plagiarized content will not be considered for publication. We reserve the right to inform authors' institutions about plagiarism detected either before or after publication. If plagiarism is identified, we will follow COPE guidelines:

Authors are solely responsible for all the plagiarism that is found. The author must not fabricate, falsify or plagiarize existing research data. The following, if copied, will be considered plagiarism:

- Words (language)
- Ideas
- Findings
- Writings
- Diagrams
- Graphs
- Illustrations
- Lectures





- Printed material
- Graphic representations
- Computer programs
- Electronic material
- Any other original work

## AUTHORSHIP POLICIES

Global Journals follows the definition of authorship set up by the Open Association of Research Society, USA. According to its guidelines, authorship criteria must be based on:

1. Substantial contributions to the conception and acquisition of data, analysis, and interpretation of findings.
2. Drafting the paper and revising it critically regarding important academic content.
3. Final approval of the version of the paper to be published.

### Changes in Authorship

The corresponding author should mention the name and complete details of all co-authors during submission and in manuscript. We support addition, rearrangement, manipulation, and deletions in authors list till the early view publication of the journal. We expect that corresponding author will notify all co-authors of submission. We follow COPE guidelines for changes in authorship.

### Copyright

During submission of the manuscript, the author is confirming an exclusive license agreement with Global Journals which gives Global Journals the authority to reproduce, reuse, and republish authors' research. We also believe in flexible copyright terms where copyright may remain with authors/employers/institutions as well. Contact your editor after acceptance to choose your copyright policy. You may follow this form for copyright transfers.

### Appealing Decisions

Unless specified in the notification, the Editorial Board's decision on publication of the paper is final and cannot be appealed before making the major change in the manuscript.

### Acknowledgments

Contributors to the research other than authors credited should be mentioned in Acknowledgments. The source of funding for the research can be included. Suppliers of resources may be mentioned along with their addresses.

### Declaration of funding sources

Global Journals is in partnership with various universities, laboratories, and other institutions worldwide in the research domain. Authors are requested to disclose their source of funding during every stage of their research, such as making analysis, performing laboratory operations, computing data, and using institutional resources, from writing an article to its submission. This will also help authors to get reimbursements by requesting an open access publication letter from Global Journals and submitting to the respective funding source.

## PREPARING YOUR MANUSCRIPT

Authors can submit papers and articles in an acceptable file format: MS Word (doc, docx), LaTeX (.tex, .zip or .rar including all of your files), Adobe PDF (.pdf), rich text format (.rtf), simple text document (.txt), Open Document Text (.odt), and Apple Pages (.pages). Our professional layout editors will format the entire paper according to our official guidelines. This is one of the highlights of publishing with Global Journals—authors should not be concerned about the formatting of their paper. Global Journals accepts articles and manuscripts in every major language, be it Spanish, Chinese, Japanese, Portuguese, Russian, French, German, Dutch, Italian, Greek, or any other national language, but the title, subtitle, and abstract should be in English. This will facilitate indexing and the pre-peer review process.

The following is the official style and template developed for publication of a research paper. Authors are not required to follow this style during the submission of the paper. It is just for reference purposes.



### ***Manuscript Style Instruction (Optional)***

- Microsoft Word Document Setting Instructions.
- Font type of all text should be Swis721 Lt BT.
- Page size: 8.27" x 11", left margin: 0.65, right margin: 0.65, bottom margin: 0.75.
- Paper title should be in one column of font size 24.
- Author name in font size of 11 in one column.
- Abstract: font size 9 with the word "Abstract" in bold italics.
- Main text: font size 10 with two justified columns.
- Two columns with equal column width of 3.38 and spacing of 0.2.
- First character must be three lines drop-capped.
- The paragraph before spacing of 1 pt and after of 0 pt.
- Line spacing of 1 pt.
- Large images must be in one column.
- The names of first main headings (Heading 1) must be in Roman font, capital letters, and font size of 10.
- The names of second main headings (Heading 2) must not include numbers and must be in italics with a font size of 10.

### ***Structure and Format of Manuscript***

The recommended size of an original research paper is under 15,000 words and review papers under 7,000 words. Research articles should be less than 10,000 words. Research papers are usually longer than review papers. Review papers are reports of significant research (typically less than 7,000 words, including tables, figures, and references)

A research paper must include:

- a) A title which should be relevant to the theme of the paper.
- b) A summary, known as an abstract (less than 150 words), containing the major results and conclusions.
- c) Up to 10 keywords that precisely identify the paper's subject, purpose, and focus.
- d) An introduction, giving fundamental background objectives.
- e) Resources and techniques with sufficient complete experimental details (wherever possible by reference) to permit repetition, sources of information must be given, and numerical methods must be specified by reference.
- f) Results which should be presented concisely by well-designed tables and figures.
- g) Suitable statistical data should also be given.
- h) All data must have been gathered with attention to numerical detail in the planning stage.

Design has been recognized to be essential to experiments for a considerable time, and the editor has decided that any paper that appears not to have adequate numerical treatments of the data will be returned unrefereed.

- i) Discussion should cover implications and consequences and not just recapitulate the results; conclusions should also be summarized.
- j) There should be brief acknowledgments.
- k) There ought to be references in the conventional format. Global Journals recommends APA format.

Authors should carefully consider the preparation of papers to ensure that they communicate effectively. Papers are much more likely to be accepted if they are carefully designed and laid out, contain few or no errors, are summarizing, and follow instructions. They will also be published with much fewer delays than those that require much technical and editorial correction.

The Editorial Board reserves the right to make literary corrections and suggestions to improve brevity.



## FORMAT STRUCTURE

***It is necessary that authors take care in submitting a manuscript that is written in simple language and adheres to published guidelines.***

All manuscripts submitted to Global Journals should include:

### **Title**

The title page must carry an informative title that reflects the content, a running title (less than 45 characters together with spaces), names of the authors and co-authors, and the place(s) where the work was carried out.

### **Author details**

The full postal address of any related author(s) must be specified.

### **Abstract**

The abstract is the foundation of the research paper. It should be clear and concise and must contain the objective of the paper and inferences drawn. It is advised to not include big mathematical equations or complicated jargon.

Many researchers searching for information online will use search engines such as Google, Yahoo or others. By optimizing your paper for search engines, you will amplify the chance of someone finding it. In turn, this will make it more likely to be viewed and cited in further works. Global Journals has compiled these guidelines to facilitate you to maximize the web-friendliness of the most public part of your paper.

### **Keywords**

A major lynchpin of research work for the writing of research papers is the keyword search, which one will employ to find both library and internet resources. Up to eleven keywords or very brief phrases have to be given to help data retrieval, mining, and indexing.

One must be persistent and creative in using keywords. An effective keyword search requires a strategy: planning of a list of possible keywords and phrases to try.

Choice of the main keywords is the first tool of writing a research paper. Research paper writing is an art. Keyword search should be as strategic as possible.

One should start brainstorming lists of potential keywords before even beginning searching. Think about the most important concepts related to research work. Ask, "What words would a source have to include to be truly valuable in a research paper?" Then consider synonyms for the important words.

It may take the discovery of only one important paper to steer in the right keyword direction because, in most databases, the keywords under which a research paper is abstracted are listed with the paper.

### **Numerical Methods**

Numerical methods used should be transparent and, where appropriate, supported by references.

### **Abbreviations**

Authors must list all the abbreviations used in the paper at the end of the paper or in a separate table before using them.

### **Formulas and equations**

Authors are advised to submit any mathematical equation using either MathJax, KaTeX, or LaTeX, or in a very high-quality image.

### **Tables, Figures, and Figure Legends**

Tables: Tables should be cautiously designed, uncrowned, and include only essential data. Each must have an Arabic number, e.g., Table 4, a self-explanatory caption, and be on a separate sheet. Authors must submit tables in an editable format and not as images. References to these tables (if any) must be mentioned accurately.



## Figures

Figures are supposed to be submitted as separate files. Always include a citation in the text for each figure using Arabic numbers, e.g., Fig. 4. Artwork must be submitted online in vector electronic form or by emailing it.

## PREPARATION OF ELECTRONIC FIGURES FOR PUBLICATION

Although low-quality images are sufficient for review purposes, print publication requires high-quality images to prevent the final product being blurred or fuzzy. Submit (possibly by e-mail) EPS (line art) or TIFF (halftone/ photographs) files only. MS PowerPoint and Word Graphics are unsuitable for printed pictures. Avoid using pixel-oriented software. Scans (TIFF only) should have a resolution of at least 350 dpi (halftone) or 700 to 1100 dpi (line drawings). Please give the data for figures in black and white or submit a Color Work Agreement form. EPS files must be saved with fonts embedded (and with a TIFF preview, if possible).

For scanned images, the scanning resolution at final image size ought to be as follows to ensure good reproduction: line art: >650 dpi; halftones (including gel photographs): >350 dpi; figures containing both halftone and line images: >650 dpi.

Color charges: Authors are advised to pay the full cost for the reproduction of their color artwork. Hence, please note that if there is color artwork in your manuscript when it is accepted for publication, we would require you to complete and return a Color Work Agreement form before your paper can be published. Also, you can email your editor to remove the color fee after acceptance of the paper.

## TIPS FOR WRITING A GOOD QUALITY ENGINEERING RESEARCH PAPER

Techniques for writing a good quality engineering research paper:

**1. Choosing the topic:** In most cases, the topic is selected by the interests of the author, but it can also be suggested by the guides. You can have several topics, and then judge which you are most comfortable with. This may be done by asking several questions of yourself, like "Will I be able to carry out a search in this area? Will I find all necessary resources to accomplish the search? Will I be able to find all information in this field area?" If the answer to this type of question is "yes," then you ought to choose that topic. In most cases, you may have to conduct surveys and visit several places. Also, you might have to do a lot of work to find all the rises and falls of the various data on that subject. Sometimes, detailed information plays a vital role, instead of short information. Evaluators are human: The first thing to remember is that evaluators are also human beings. They are not only meant for rejecting a paper. They are here to evaluate your paper. So present your best aspect.

**2. Think like evaluators:** If you are in confusion or getting demotivated because your paper may not be accepted by the evaluators, then think, and try to evaluate your paper like an evaluator. Try to understand what an evaluator wants in your research paper, and you will automatically have your answer. Make blueprints of paper: The outline is the plan or framework that will help you to arrange your thoughts. It will make your paper logical. But remember that all points of your outline must be related to the topic you have chosen.

**3. Ask your guides:** If you are having any difficulty with your research, then do not hesitate to share your difficulty with your guide (if you have one). They will surely help you out and resolve your doubts. If you can't clarify what exactly you require for your work, then ask your supervisor to help you with an alternative. He or she might also provide you with a list of essential readings.

**4. Use of computer is recommended:** As you are doing research in the field of research engineering then this point is quite obvious. Use right software: Always use good quality software packages. If you are not capable of judging good software, then you can lose the quality of your paper unknowingly. There are various programs available to help you which you can get through the internet.

**5. Use the internet for help:** An excellent start for your paper is using Google. It is a wondrous search engine, where you can have your doubts resolved. You may also read some answers for the frequent question of how to write your research paper or find a model research paper. You can download books from the internet. If you have all the required books, place importance on reading, selecting, and analyzing the specified information. Then sketch out your research paper. Use big pictures: You may use encyclopedias like Wikipedia to get pictures with the best resolution. At Global Journals, you should strictly follow [here](#).



**6. Bookmarks are useful:** When you read any book or magazine, you generally use bookmarks, right? It is a good habit which helps to not lose your continuity. You should always use bookmarks while searching on the internet also, which will make your search easier.

**7. Revise what you wrote:** When you write anything, always read it, summarize it, and then finalize it.

**8. Make every effort:** Make every effort to mention what you are going to write in your paper. That means always have a good start. Try to mention everything in the introduction—what is the need for a particular research paper. Polish your work with good writing skills and always give an evaluator what he wants. Make backups: When you are going to do any important thing like making a research paper, you should always have backup copies of it either on your computer or on paper. This protects you from losing any portion of your important data.

**9. Produce good diagrams of your own:** Always try to include good charts or diagrams in your paper to improve quality. Using several unnecessary diagrams will degrade the quality of your paper by creating a hodgepodge. So always try to include diagrams which were made by you to improve the readability of your paper. Use of direct quotes: When you do research relevant to literature, history, or current affairs, then use of quotes becomes essential, but if the study is relevant to science, use of quotes is not preferable.

**10. Use proper verb tense:** Use proper verb tenses in your paper. Use past tense to present those events that have happened. Use present tense to indicate events that are going on. Use future tense to indicate events that will happen in the future. Use of wrong tenses will confuse the evaluator. Avoid sentences that are incomplete.

**11. Pick a good study spot:** Always try to pick a spot for your research which is quiet. Not every spot is good for studying.

**12. Know what you know:** Always try to know what you know by making objectives, otherwise you will be confused and unable to achieve your target.

**13. Use good grammar:** Always use good grammar and words that will have a positive impact on the evaluator; use of good vocabulary does not mean using tough words which the evaluator has to find in a dictionary. Do not fragment sentences. Eliminate one-word sentences. Do not ever use a big word when a smaller one would suffice.

Verbs have to be in agreement with their subjects. In a research paper, do not start sentences with conjunctions or finish them with prepositions. When writing formally, it is advisable to never split an infinitive because someone will (wrongly) complain. Avoid clichés like a disease. Always shun irritating alliteration. Use language which is simple and straightforward. Put together a neat summary.

**14. Arrangement of information:** Each section of the main body should start with an opening sentence, and there should be a changeover at the end of the section. Give only valid and powerful arguments for your topic. You may also maintain your arguments with records.

**15. Never start at the last minute:** Always allow enough time for research work. Leaving everything to the last minute will degrade your paper and spoil your work.

**16. Multitasking in research is not good:** Doing several things at the same time is a bad habit in the case of research activity. Research is an area where everything has a particular time slot. Divide your research work into parts, and do a particular part in a particular time slot.

**17. Never copy others' work:** Never copy others' work and give it your name because if the evaluator has seen it anywhere, you will be in trouble. Take proper rest and food: No matter how many hours you spend on your research activity, if you are not taking care of your health, then all your efforts will have been in vain. For quality research, take proper rest and food.

**18. Go to seminars:** Attend seminars if the topic is relevant to your research area. Utilize all your resources.

**19. Refresh your mind after intervals:** Try to give your mind a rest by listening to soft music or sleeping in intervals. This will also improve your memory. Acquire colleagues: Always try to acquire colleagues. No matter how sharp you are, if you acquire colleagues, they can give you ideas which will be helpful to your research.

**20. Think technically:** Always think technically. If anything happens, search for its reasons, benefits, and demerits. Think and then print: When you go to print your paper, check that tables are not split, headings are not detached from their descriptions, and page sequence is maintained.



**21. Adding unnecessary information:** Do not add unnecessary information like "I have used MS Excel to draw graphs." Irrelevant and inappropriate material is superfluous. Foreign terminology and phrases are not apropos. One should never take a broad view. Analogy is like feathers on a snake. Use words properly, regardless of how others use them. Remove quotations. Puns are for kids, not grunt readers. Never oversimplify: When adding material to your research paper, never go for oversimplification; this will definitely irritate the evaluator. Be specific. Never use rhythmic redundancies. Contractions shouldn't be used in a research paper. Comparisons are as terrible as clichés. Give up ampersands, abbreviations, and so on. Remove commas that are not necessary. Parenthetical words should be between brackets or commas. Understatement is always the best way to put forward earth-shaking thoughts. Give a detailed literary review.

**22. Report concluded results:** Use concluded results. From raw data, filter the results, and then conclude your studies based on measurements and observations taken. An appropriate number of decimal places should be used. Parenthetical remarks are prohibited here. Proofread carefully at the final stage. At the end, give an outline to your arguments. Spot perspectives of further study of the subject. Justify your conclusion at the bottom sufficiently, which will probably include examples.

**23. Upon conclusion:** Once you have concluded your research, the next most important step is to present your findings. Presentation is extremely important as it is the definite medium through which your research is going to be in print for the rest of the crowd. Care should be taken to categorize your thoughts well and present them in a logical and neat manner. A good quality research paper format is essential because it serves to highlight your research paper and bring to light all necessary aspects of your research.

## INFORMAL GUIDELINES OF RESEARCH PAPER WRITING

### **Key points to remember:**

- Submit all work in its final form.
- Write your paper in the form which is presented in the guidelines using the template.
- Please note the criteria peer reviewers will use for grading the final paper.

### **Final points:**

One purpose of organizing a research paper is to let people interpret your efforts selectively. The journal requires the following sections, submitted in the order listed, with each section starting on a new page:

*The introduction:* This will be compiled from reference matter and reflect the design processes or outline of basis that directed you to make a study. As you carry out the process of study, the method and process section will be constructed like that. The results segment will show related statistics in nearly sequential order and direct reviewers to similar intellectual paths throughout the data that you gathered to carry out your study.

### **The discussion section:**

This will provide understanding of the data and projections as to the implications of the results. The use of good quality references throughout the paper will give the effort trustworthiness by representing an alertness to prior workings.

Writing a research paper is not an easy job, no matter how trouble-free the actual research or concept. Practice, excellent preparation, and controlled record-keeping are the only means to make straightforward progression.

### **General style:**

Specific editorial column necessities for compliance of a manuscript will always take over from directions in these general guidelines.

**To make a paper clear:** Adhere to recommended page limits.

### *Mistakes to avoid:*

- Insertion of a title at the foot of a page with subsequent text on the next page.
- Separating a table, chart, or figure—confine each to a single page.
- Submitting a manuscript with pages out of sequence.
- In every section of your document, use standard writing style, including articles ("a" and "the").
- Keep paying attention to the topic of the paper.



- Use paragraphs to split each significant point (excluding the abstract).
- Align the primary line of each section.
- Present your points in sound order.
- Use present tense to report well-accepted matters.
- Use past tense to describe specific results.
- Do not use familiar wording; don't address the reviewer directly. Don't use slang or superlatives.
- Avoid use of extra pictures—include only those figures essential to presenting results.

#### **Title page:**

Choose a revealing title. It should be short and include the name(s) and address(es) of all authors. It should not have acronyms or abbreviations or exceed two printed lines.

**Abstract:** This summary should be two hundred words or less. It should clearly and briefly explain the key findings reported in the manuscript and must have precise statistics. It should not have acronyms or abbreviations. It should be logical in itself. Do not cite references at this point.

An abstract is a brief, distinct paragraph summary of finished work or work in development. In a minute or less, a reviewer can be taught the foundation behind the study, common approaches to the problem, relevant results, and significant conclusions or new questions.

Write your summary when your paper is completed because how can you write the summary of anything which is not yet written? Wealth of terminology is very essential in abstract. Use comprehensive sentences, and do not sacrifice readability for brevity; you can maintain it succinctly by phrasing sentences so that they provide more than a lone rationale. The author can at this moment go straight to shortening the outcome. Sum up the study with the subsequent elements in any summary. Try to limit the initial two items to no more than one line each.

*Reason for writing the article—theory, overall issue, purpose.*

- Fundamental goal.
- To-the-point depiction of the research.
- Consequences, including definite statistics—if the consequences are quantitative in nature, account for this; results of any numerical analysis should be reported. Significant conclusions or questions that emerge from the research.

#### **Approach:**

- Single section and succinct.
- An outline of the job done is always written in past tense.
- Concentrate on shortening results—limit background information to a verdict or two.
- Exact spelling, clarity of sentences and phrases, and appropriate reporting of quantities (proper units, important statistics) are just as significant in an abstract as they are anywhere else.

#### **Introduction:**

The introduction should "introduce" the manuscript. The reviewer should be presented with sufficient background information to be capable of comprehending and calculating the purpose of your study without having to refer to other works. The basis for the study should be offered. Give the most important references, but avoid making a comprehensive appraisal of the topic. Describe the problem visibly. If the problem is not acknowledged in a logical, reasonable way, the reviewer will give no attention to your results. Speak in common terms about techniques used to explain the problem, if needed, but do not present any particulars about the protocols here.

*The following approach can create a valuable beginning:*

- Explain the value (significance) of the study.
- Defend the model—why did you employ this particular system or method? What is its compensation? Remark upon its appropriateness from an abstract point of view as well as pointing out sensible reasons for using it.
- Present a justification. State your particular theory(-ies) or aim(s), and describe the logic that led you to choose them.
- Briefly explain the study's tentative purpose and how it meets the declared objectives.



**Approach:**

Use past tense except for when referring to recognized facts. After all, the manuscript will be submitted after the entire job is done. Sort out your thoughts; manufacture one key point for every section. If you make the four points listed above, you will need at least four paragraphs. Present surrounding information only when it is necessary to support a situation. The reviewer does not desire to read everything you know about a topic. Shape the theory specifically—do not take a broad view.

As always, give awareness to spelling, simplicity, and correctness of sentences and phrases.

**Procedures (methods and materials):**

This part is supposed to be the easiest to carve if you have good skills. A soundly written procedures segment allows a capable scientist to replicate your results. Present precise information about your supplies. The suppliers and clarity of reagents can be helpful bits of information. Present methods in sequential order, but linked methodologies can be grouped as a segment. Be concise when relating the protocols. Attempt to give the least amount of information that would permit another capable scientist to replicate your outcome, but be cautious that vital information is integrated. The use of subheadings is suggested and ought to be synchronized with the results section.

When a technique is used that has been well-described in another section, mention the specific item describing the way, but draw the basic principle while stating the situation. The purpose is to show all particular resources and broad procedures so that another person may use some or all of the methods in one more study or referee the scientific value of your work. It is not to be a step-by-step report of the whole thing you did, nor is a methods section a set of orders.

**Materials:**

*Materials may be reported in part of a section or else they may be recognized along with your measures.*

**Methods:**

- Report the method and not the particulars of each process that engaged the same methodology.
- Describe the method entirely.
- To be succinct, present methods under headings dedicated to specific dealings or groups of measures.
- Simplify—detail how procedures were completed, not how they were performed on a particular day.
- If well-known procedures were used, account for the procedure by name, possibly with a reference, and that's all.

**Approach:**

It is embarrassing to use vigorous voice when documenting methods without using first person, which would focus the reviewer's interest on the researcher rather than the job. As a result, when writing up the methods, most authors use third person passive voice.

Use standard style in this and every other part of the paper—avoid familiar lists, and use full sentences.

**What to keep away from:**

- Resources and methods are not a set of information.
- Skip all descriptive information and surroundings—save it for the argument.
- Leave out information that is immaterial to a third party.

**Results:**

The principle of a results segment is to present and demonstrate your conclusion. Create this part as entirely objective details of the outcome, and save all understanding for the discussion.

The page length of this segment is set by the sum and types of data to be reported. Use statistics and tables, if suitable, to present consequences most efficiently.

You must clearly differentiate material which would usually be incorporated in a study editorial from any unprocessed data or additional appendix matter that would not be available. In fact, such matters should not be submitted at all except if requested by the instructor.





**Content:**

- Sum up your conclusions in text and demonstrate them, if suitable, with figures and tables.
- In the manuscript, explain each of your consequences, and point the reader to remarks that are most appropriate.
- Present a background, such as by describing the question that was addressed by creation of an exacting study.
- Explain results of control experiments and give remarks that are not accessible in a prescribed figure or table, if appropriate.
- Examine your data, then prepare the analyzed (transformed) data in the form of a figure (graph), table, or manuscript.

**What to stay away from:**

- Do not discuss or infer your outcome, report surrounding information, or try to explain anything.
- Do not include raw data or intermediate calculations in a research manuscript.
- Do not present similar data more than once.
- A manuscript should complement any figures or tables, not duplicate information.
- Never confuse figures with tables—there is a difference.

**Approach:**

As always, use past tense when you submit your results, and put the whole thing in a reasonable order.

Put figures and tables, appropriately numbered, in order at the end of the report.

If you desire, you may place your figures and tables properly within the text of your results section.

**Figures and tables:**

If you put figures and tables at the end of some details, make certain that they are visibly distinguished from any attached appendix materials, such as raw facts. Whatever the position, each table must be titled, numbered one after the other, and include a heading. All figures and tables must be divided from the text.

**Discussion:**

The discussion is expected to be the trickiest segment to write. A lot of papers submitted to the journal are discarded based on problems with the discussion. There is no rule for how long an argument should be.

Position your understanding of the outcome visibly to lead the reviewer through your conclusions, and then finish the paper with a summing up of the implications of the study. The purpose here is to offer an understanding of your results and support all of your conclusions, using facts from your research and generally accepted information, if suitable. The implication of results should be fully described.

Infer your data in the conversation in suitable depth. This means that when you clarify an observable fact, you must explain mechanisms that may account for the observation. If your results vary from your prospect, make clear why that may have happened. If your results agree, then explain the theory that the proof supported. It is never suitable to just state that the data approved the prospect, and let it drop at that. Make a decision as to whether each premise is supported or discarded or if you cannot make a conclusion with assurance. Do not just dismiss a study or part of a study as "uncertain."

Research papers are not acknowledged if the work is imperfect. Draw what conclusions you can based upon the results that you have, and take care of the study as a finished work.

- You may propose future guidelines, such as how an experiment might be personalized to accomplish a new idea.
- Give details of all of your remarks as much as possible, focusing on mechanisms.
- Make a decision as to whether the tentative design sufficiently addressed the theory and whether or not it was correctly restricted. Try to present substitute explanations if they are sensible alternatives.
- One piece of research will not counter an overall question, so maintain the large picture in mind. Where do you go next? The best studies unlock new avenues of study. What questions remain?
- Recommendations for detailed papers will offer supplementary suggestions.



**Approach:**

When you refer to information, differentiate data generated by your own studies from other available information. Present work done by specific persons (including you) in past tense.

Describe generally acknowledged facts and main beliefs in present tense.

## THE ADMINISTRATION RULES

Administration Rules to Be Strictly Followed before Submitting Your Research Paper to Global Journals Inc.

*Please read the following rules and regulations carefully before submitting your research paper to Global Journals Inc. to avoid rejection.*

*Segment draft and final research paper:* You have to strictly follow the template of a research paper, failing which your paper may get rejected. You are expected to write each part of the paper wholly on your own. The peer reviewers need to identify your own perspective of the concepts in your own terms. Please do not extract straight from any other source, and do not rephrase someone else's analysis. Do not allow anyone else to proofread your manuscript.

*Written material:* You may discuss this with your guides and key sources. Do not copy anyone else's paper, even if this is only imitation, otherwise it will be rejected on the grounds of plagiarism, which is illegal. Various methods to avoid plagiarism are strictly applied by us to every paper, and, if found guilty, you may be blacklisted, which could affect your career adversely. To guard yourself and others from possible illegal use, please do not permit anyone to use or even read your paper and file.



CRITERION FOR GRADING A RESEARCH PAPER (COMPILATION)  
BY GLOBAL JOURNALS

Please note that following table is only a Grading of "Paper Compilation" and not on "Performed/Stated Research" whose grading solely depends on Individual Assigned Peer Reviewer and Editorial Board Member. These can be available only on request and after decision of Paper. This report will be the property of Global Journals.

Topics	Grades		
	A-B	C-D	E-F
<i>Abstract</i>	Clear and concise with appropriate content, Correct format. 200 words or below	Unclear summary and no specific data, Incorrect form  Above 200 words	No specific data with ambiguous information  Above 250 words
<i>Introduction</i>	Containing all background details with clear goal and appropriate details, flow specification, no grammar and spelling mistake, well organized sentence and paragraph, reference cited	Unclear and confusing data, appropriate format, grammar and spelling errors with unorganized matter	Out of place depth and content, hazy format
<i>Methods and Procedures</i>	Clear and to the point with well arranged paragraph, precision and accuracy of facts and figures, well organized subheads	Difficult to comprehend with embarrassed text, too much explanation but completed	Incorrect and unorganized structure with hazy meaning
<i>Result</i>	Well organized, Clear and specific, Correct units with precision, correct data, well structuring of paragraph, no grammar and spelling mistake	Complete and embarrassed text, difficult to comprehend	Irregular format with wrong facts and figures
<i>Discussion</i>	Well organized, meaningful specification, sound conclusion, logical and concise explanation, highly structured paragraph reference cited	Wordy, unclear conclusion, spurious	Conclusion is not cited, unorganized, difficult to comprehend
<i>References</i>	Complete and correct format, well organized	Beside the point, Incomplete	Wrong format and structuring



# INDEX

---

---

## **A**

Apoptosis · 28

---

## **C**

Cipher · 32, 34  
Concatenation · 32, 36  
Cryptographic · 32, 34, 38, 39

---

## **D**

Detrimental · 28

---

## **I**

Inoculum · 22  
Intricate · 21  
Iterative · 39

---

## **M**

Metabolomics · 29  
Monoclonal · 21  
Multivariate · 21, 23, 29, 30

---

## **P**

Proteomic · 21

---

## **R**

Reassert · 26

---

## **S**

Stemming · 2  
Supernatant · 22, 23

---

## **T**

Tetrahydrofolate · 28  
Therapeutic · 21, 31

---

## **U**

Univariate · 23



save our planet



# Global Journal of Researches in Engineering

Visit us on the Web at [www.GlobalJournals.org](http://www.GlobalJournals.org) | [www.EngineeringResearch.org](http://www.EngineeringResearch.org)  
or email us at [helpdesk@globaljournals.org](mailto:helpdesk@globaljournals.org)

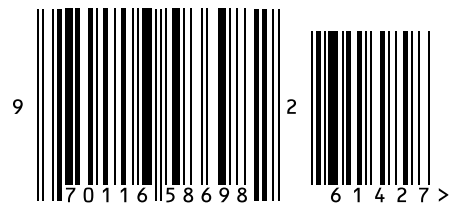

ISSN 9755861

© Global Journals