



GLOBAL JOURNAL OF RESEARCHES IN ENGINEERING: D
AEROSPACE SCIENCE
Volume 23 Issue 1 Version 1.0 Year 2023
Type: Double Blind Peer Reviewed International Research Journal
Publisher: Global Journals
Online ISSN: 2249-4596 & Print ISSN: 0975-5861

Study on the Influence of UAV Wingtip Connection on Ceiling and Endurance

By Wei Zhou, Peiyang Ma, Qiuyan Wang, Xueqian Shi & Kaixuan Liu

Rocket Force University of Engineering

Abstract- The cluster UAVs have developed rapidly in recent years with the advantages of low cost, expandability and high reliability. However, due to their small size, they have the shortages of range and flight time. Wingtip connection technology, as an important way to increase the range and flight time of fixed-wing cluster UAVs, has also developed rapidly in recent years. From the theoretical analysis, it is concluded that the wingtip connection can effectively improve the aerodynamic characteristics of fixed-wing UAVs, and the conclusions are validated by vortex lattice method simulation. Based on this, the influence of the number of units on the flight performance of the combination is analysed theoretically. As the number of units increases, the combination can have higher ceiling, larger range and longer flight time.

GJRE-D Classification: FOR Code: 090199



Strictly as per the compliance and regulations of:



© 2023. Wei Zhou, Peiyang Ma, Qiuyan Wang, Xueqian Shi & Kaixuan Liu. This research/review article is distributed under the terms of the Attribution-NonCommercial-NoDerivatives 4.0 International (CC BYNCND 4.0). You must give appropriate credit to authors and reference this article if parts of the article are reproduced in any manner. Applicable licensing terms are at <https://creativecommons.org/licenses/by-nc-nd/4.0/>.

Study on the Influence of UAV Wingtip Connection on Ceiling and Endurance

Wei Zhou ^α, Peiyang Ma ^σ, Qiuyan Wang ^ρ, Xueqian Shi ^ω & Kaixuan Liu [¥]

Abstract- The cluster UAVs have developed rapidly in recent years with the advantages of low cost, expandability and high reliability. However, due to their small size, they have the shortages of range and flight time. Wingtip connection technology, as an important way to increase the range and flight time of fixed-wing cluster UAVs, has also developed rapidly in recent years. From the theoretical analysis, it is concluded that the wingtip connection can effectively improve the aerodynamic characteristics of fixed-wing UAVs, and the conclusions are validated by vortex lattice method simulation. Based on this, the influence of the number of units on the flight performance of the combination is analysed theoretically. As the number of units increases, the combination can have higher ceiling, larger range and longer flight time.

I. INTRODUCTION

With the increasingly complex battlefield environment, the war has put forward higher requirements for the mission capability and viability of UAVs. The cost of large strategic deterrence UAVs continues to rise, and the cluster UAVs have gradually become a new focus ^[1]. However, due to the cost and volume constraints, cluster UAVs are inherently short of range and endurance. At present, there are three common methods to improve the range and endurance of the aircraft: First, the aerial refuelling technology is adopted, but for a large number of cluster UAVs, the efficiency of aerial refuelling cannot meet the actual needs. The second is to use a large aspect ratio design combined with solar power module, but for clustered UAVs that need high flexibility and mobility, the aspect ratio will be greatly limited, while the small aspect ratio combined with solar power module will have very low income. Third, like the "Gremlins" in the United States, large transport planes are used for long-distance delivery, but this only solves the problem of long distance, not the endurance time.

In recent years, with the rise of clustered UAVs, a technology that once appeared has been re-valued, namely wingtip connection technology. Scientists hope that the fixed-wing cluster UAVs can form a combination with a large aspect ratio through wingtip connection. At this time, if the UAVs combined with solar technology, the range and endurance time can be greatly extended ^[2].

Wingtip connection was first proposed by Richard Vogt, a German scientist who immigrated to the United States after World War II. Based on this concept, the United States carried out "MX-1018" (Tip-Tow) and "Tom Tom" projects. However, due to the aerodynamic interference at the wingtip, this research has caused great potential safety hazards and even casualties. In addition, the impact of the gradual maturity of aerial refuelling technology at that time temporarily caused the flight test of wingtip connection stop ^[3].

Since the 21st century, scientists in the United States, Germany and China have seen the great value of wingtip connection, see Figure 1, for it can improve the ceiling and endurance of cluster UAVs, and gradually resumed and accelerated the study on wingtip connection. Through computational fluid dynamics analysis and wind tunnel test, American scientists analysed and studied aerodynamics and aerodynamic control in the process of wingtip connection ^[4-7], and verified the flight control system through flight test ^[8-10]; German scientists mainly explored and practiced the wingtip connection technology in engineering ^[11], and focused on designing the control system of the combination ^[12]; Since 2018, China has started the exploration and study of relevant technologies, demonstrated that wingtip connection can improve range and endurance ^[13, 14], and conducted relevant flight tests ^[15, 16].

Author ^α ^σ ^ρ ^ω [¥]: Rocket Force University of Engineering, Xi'an, China.
e-mail: mpy314159@126.com



Figure 1: Cluster UAVs with wingtip connection

In this paper, through the study on the aerodynamic theory of the UAV combination, simulation and example verification are carried out on the improvement of the ceiling and endurance of the wingtip connection, so as to verify that the clustered UAVs can improve the ceiling and endurance by wingtip connection.

II. BASIC THEORETICAL RESEARCH ON FLIGHT PERFORMANCE OF WINGTIP CONNECTION

Taking the conventional aircraft with a wing, without offset, dihedral and twist, as an example, the aerodynamic performance of the combination formed by the wingtip connection of the flying units with identical n frames is analysed theoretically.

a) Effect of Wingtip Connection on Lift-drag Ratio

Lift-drag ratio is the most intuitive embodiment of aircraft aerodynamic performance. The larger the lift-

drag ratio, the better the aerodynamic performance. In this section, it is assumed that the external environment before and after wingtip connection is unchanged, and the flight altitude and speed of the aircraft are unchanged. When the flight state is approximately at the minimum resistance, the endurance can reach the maximum. This is an ideal state, which can predict the trend and simplify the formula. For this state, there is always a waste resistance coefficient, C_{D0n} , equal to the induced resistance coefficient, C_{Din} , because the induced resistance is inversely proportional to the square of the velocity, and the waste resistance is proportional to the square of the velocity. When the two are equal, the total resistance is the smallest, see Figure 2, that is

$$C_{Dn} = C_{Din} + C_{D0n} = 2C_{D0n} \tag{1}$$

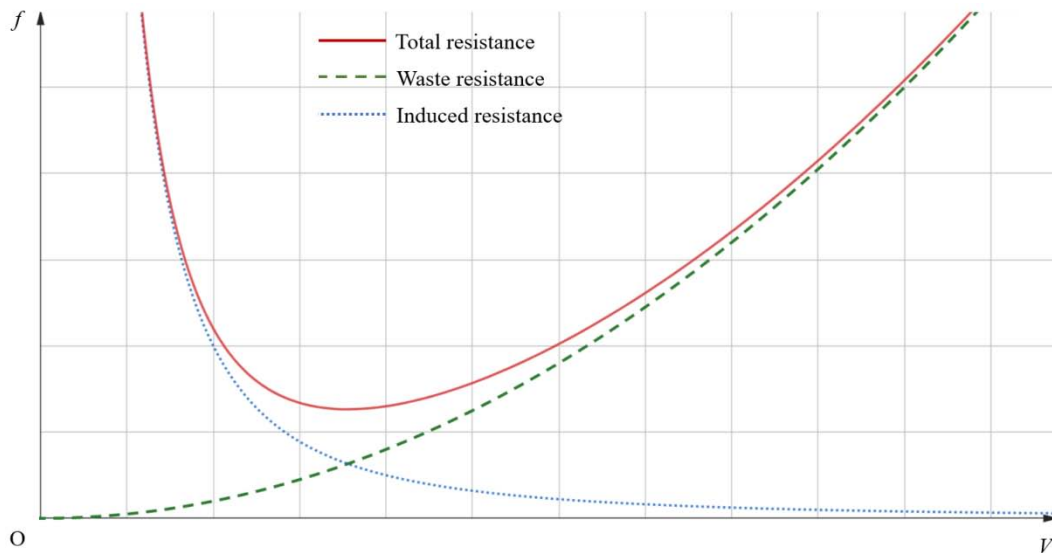

Figure 2: Relationship between resistance and speed

Of which,

$$\begin{cases} C_{D0n} = \frac{C_{Ln}^2}{\pi A_n e_n} \\ A_n = nA \end{cases} \tag{2}$$

Where, C_D is the resistance coefficient, C_L is the lift coefficient, and A is the aspect ratio, e is Oswald efficiency factor, and the lower corner mark n represents the number of same flight units formed the combination.



The lift-drag ratio, K , can be derived from equations (1) and (2).

$$K_n = \frac{C_{L_n}}{C_{D_n}} = \frac{\sqrt{\pi A_n e_n}}{\sqrt{4C_{D0_n}}} = \sqrt{\frac{\pi A}{4C_{D0_n}}} \cdot \sqrt{ne_n} \quad (3)$$

Under the assumptions in this section, the parasitic resistance coefficient of the combination is equal to the coefficient of the flight unit, which is a

constant, that is $C_{D0_n} = C_{D0} \sqrt{\frac{\pi A}{4C_{D0_n}}}$.

$$K_n \propto \sqrt{ne_n} \quad (4)$$

That is, the lift-drag ratio of the assembly K_n is proportional to $\sqrt{ne_n}$. Here, the Oswald efficiency factor can be calculated according to the formula mentioned in literature [2], that is

$$e_n = \frac{1}{\pi n A k C_{d0} + 1/(\mu s)} \quad (5)$$

Where, according to the Oswald efficiency coefficient of the high aspect ratio wing, k is assumed to be 0.18^[17], C_{d0} is the resistance coefficient of the airfoil, μ is the theoretical Oswald coefficient without considering the influence of the fuselage, s indicating the influence of the fuselage on the induced resistance, which is a function of the fuselage diameter d and the wingspan b .

$$s = 1 - 2\left(\frac{d}{b}\right)^2 \quad (6)$$

For the specified flight unit, in equation (5), all are constants except e_n and n , so it is advisable to set

$$\begin{cases} k_1 = \pi A k C_{d0} \\ k_2 = 1/(\mu s) \end{cases} \quad (7)$$

Then equation (5) can be reduced to

$$e_n = \frac{1}{k_1 n + k_2} \quad (8)$$

It can be seen that Oswald efficiency factor decreases with n increasing.

b) Effect of Wingtip Connection on Cruise Speed

This section assumes that the maximum lift-drag ratio point of the flight unit is taken at 0° , so that the cruise speed of the flight unit is the speed of horizontal flight at 0° angle of attack. It is assumed that the force balance of flight units before and after the wingtip connection is always satisfied, and the flight altitude remains unchanged.

Define that in the two-dimensional plane, the horizontal flight direction of the aircraft is the x-axis positive direction, and the y-axis is perpendicular to the x-axis and upward. Carry out force analysis on the X and Y directions of the aircraft respectively, and then equation (9) is on X axis, equation (10) is on Y axis.

$$F_n = D_n = \frac{1}{2} \rho_n V_n^2 C_{D_n} S_n \quad (9)$$

$$G_n = L_n = \frac{1}{2} \rho_n V_n^2 C_{L_n} S_n \quad (10)$$

It can be seen from equation (9) and (10),

$$F_n = G_n / K_n \quad (11)$$

That is, when the maximum lift-drag ratio is reached, the cruising pull is the smallest, so that the endurance time is the longest.

The lift coefficient calculation formula given by reference [15] under the constant speed assumption.

$$C_{L_n} \approx \left(\frac{1}{2} \rho_n V_n^2\right)^{-1} \frac{nL_i - 2\Delta L}{nS} = \left(\frac{1}{2} \rho_n V_n^2\right)^{-1} \left(\frac{L_i}{S} - 2\frac{\Delta L}{nS}\right) \quad (12)$$

It can be seen that the lift coefficient increases with the increasing of n . Where L_i is the ideal lift of a single wing calculated according to the two-dimensional infinite length model, and ΔL is the lift difference for one side of a single wing. Under the assumption of this section, when G_n unchanged, V_n gradually decreases with the increase of C_{L_n} , and equation (10) can be reduced to equation (13).

$$V_n \propto \sqrt{\frac{1}{C_{L_n}}} \quad (13)$$

That is, the cruising speed of the combination is inversely proportional to $\sqrt{C_{L_n}}$.

III. SIMULATION STUDY ON FLIGHT PERFORMANCE OF WINGTIP CONNECTION

The vortex lattice method is used to simulate the aerodynamic performance of the wingtip connection. Under the constant lift mode, the simplified full USA-35b airfoil model of a rectangular wing with 3 m wingspan and 0.4 m chord length is calculated, as shown in Figure 3, assuming that the wingtip is rigidly connected and there is no gap. The mass of the flight unit is 60 kg, when the angle of attack is $\alpha = 0^\circ$ and the torque coefficient $C_m = 0$ at approximately the maximum lift-drag ratio.

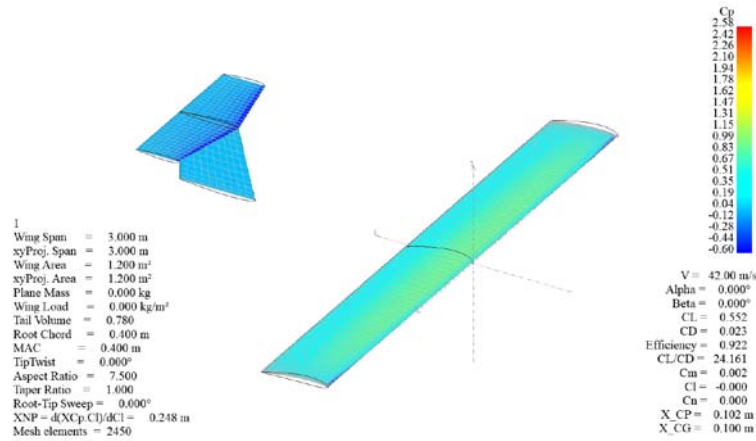
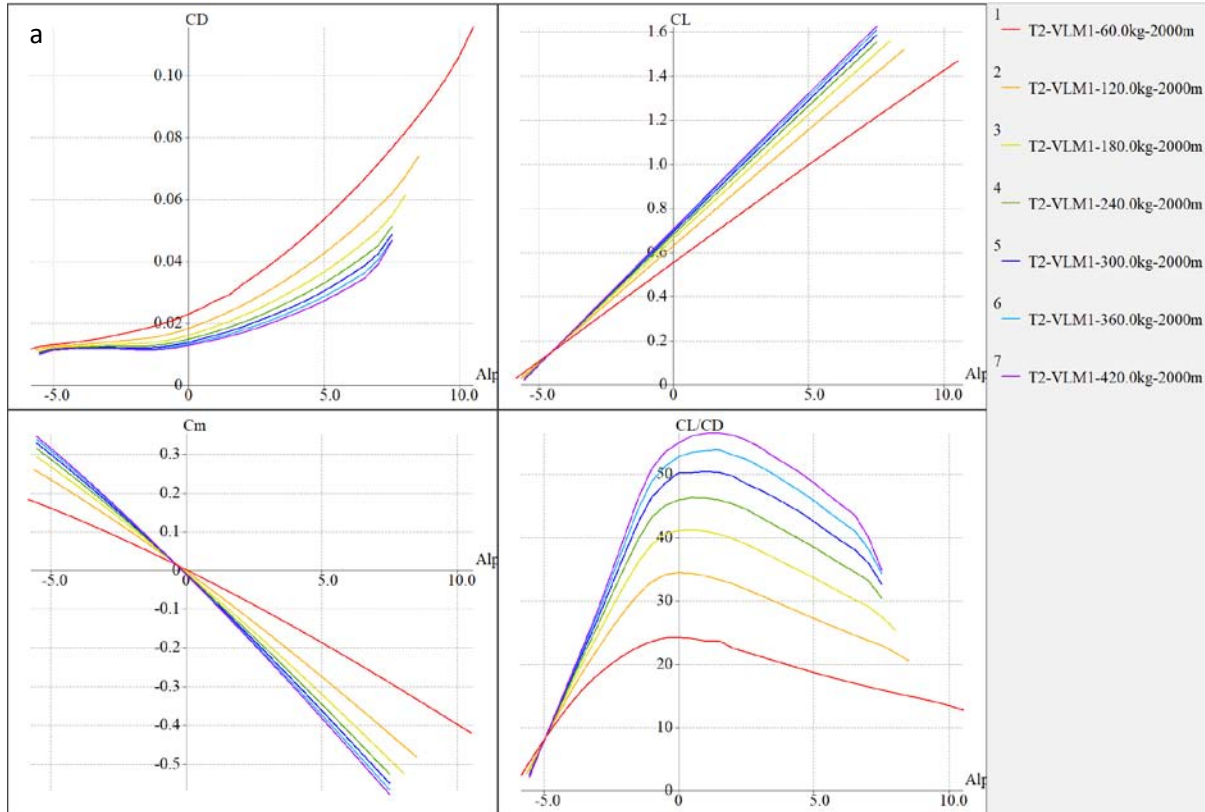

Figure 3: Simulation Model of flight unit

The approximate equivalent method of direct size increase is used in the calculation of the combination, which will lead to some errors in the simulation results. This method is used to simulate the

changes of lift-drag ratio and flight speed with different number of units. The simulation results of aerodynamic characteristics at an altitude of 2000 m are shown in Figure 4.



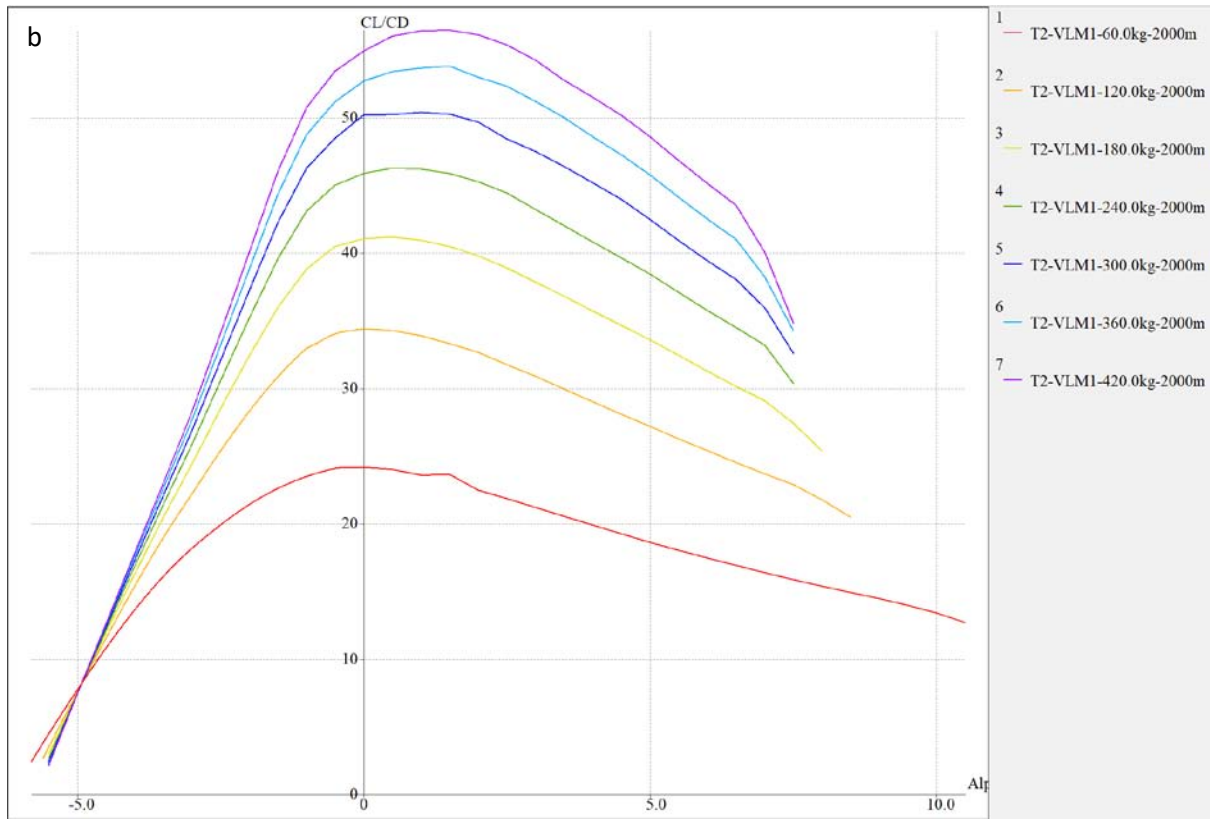

Figure 4: Variation of aerodynamic parameters vary with respect to the number of units in the assembly. (a) Variation of lift coefficient, resistance coefficient, torque coefficient and lift-drag ratio with respect to angle of attack. (b) Variation of lift-drag ratio with respect to angle of attack

See Table 1 for the sorted data, and draw Figure 5 for the simulation lift-drag ratio at 0° and the calculated theoretical lift-drag ratio. It can be seen that the law of lift-drag ratio approximately meets \sqrt{n} times,

and the failure to reach \sqrt{n} times is caused by $e_n < 1$. This result is consistent with the conclusion in Section 2.1.

Table 1: Data of calculation and simulation

n	Simulated lift-drag ratio	Theoretical lift-drag ratio	Speed[m/s]	Lift coefficient	$C_{L_n} \cdot V_n^2$
1	24.161	24.161	42.00	0.553	975.49
2	34.397	34.164	39.38	0.629	975.44
3	41.050	41.847	38.40	0.661	974.68
4	45.870	48.322	37.88	0.679	974.29
5	50.199	54.024	37.56	0.691	974.83
6	53.539	59.170	37.34	0.699	974.60
7	56.095	63.930	37.18	0.705	974.56

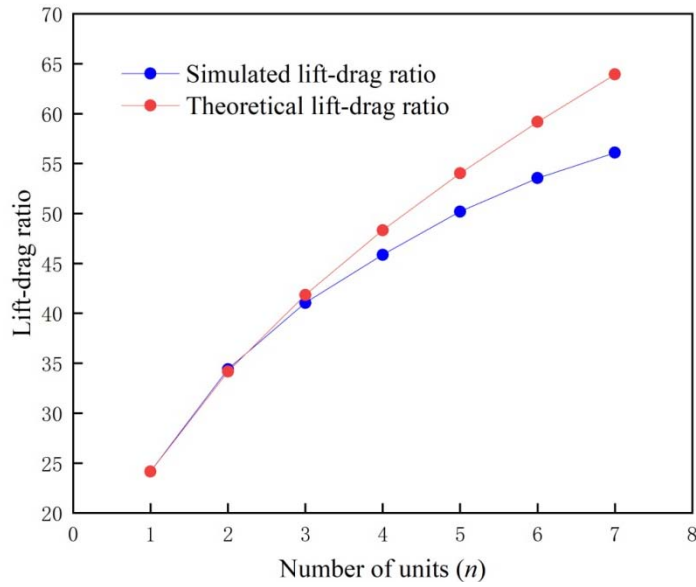

Figure 5: Relationship between lift-drag ratio and 1n

Shown in Figure 6, two parameters of lift coefficient and flight speed with different n are extracted from the simulation results. It can be seen that the demand for cruise speed gradually decreases with the

increase of n, thus reducing the consumption of power and energy. The relationship between $C_{L_n} \cdot V_n^2$ and n is shown in Figure 7, verifying equation (13), which is consistent with the conclusion in Section 2.2.

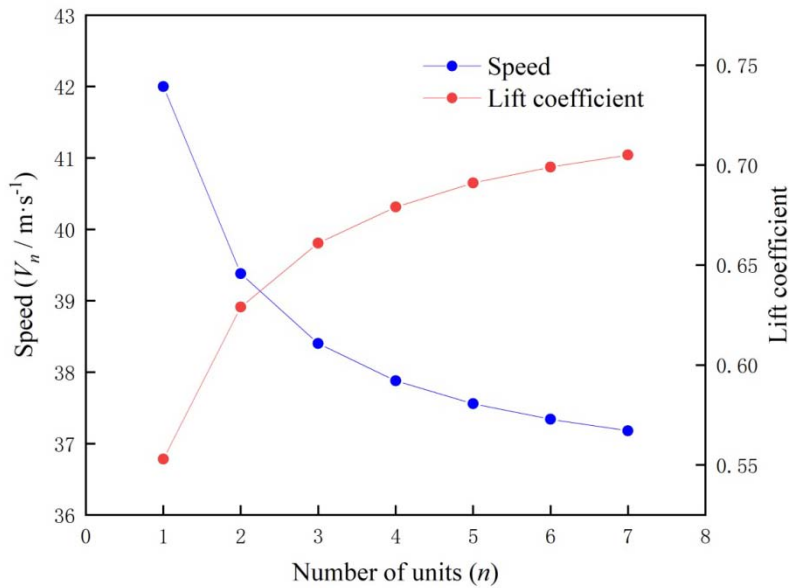

Figure 6: Relationship between lift coefficient, flight speed and n



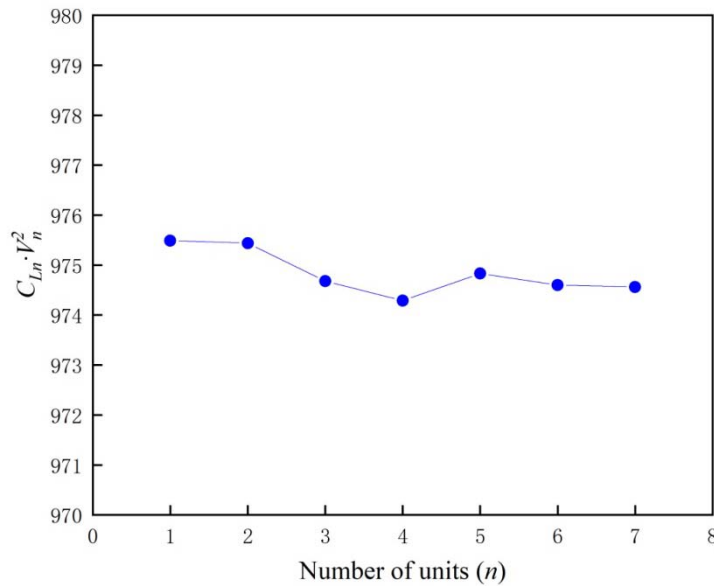

Figure 7: Relationship between $C_{L_n} \cdot V_n^2$ and n

IV. EFFECT OF WINGTIP CONNECTION ON CRUISE PERFORMANCE

In this section, it is assumed that the flight unit or combination will fly at a constant speed and level under the condition of force balance.

a) Influence of Different Heights and Unit Numbers on Tensile Demand

When n is constant, both G_n and S_n are constant, too. Then let equation (10) be reduced to $k_3 = \rho_n V_n^2 C_{L_n}$.

$$G_n = L_n = \frac{1}{2} S_n k_3 \tag{14}$$

It can be seen that G_n , S_n and k_3 remain unchanged when the height changes. Then equation (9) can be reduced to

$$F_n = D_n = \frac{1}{2} S_n k_3 \frac{1}{K_n} \tag{15}$$

That is, when the flight altitude changes, the pull required for the level flight of the combination is only related to the lift-drag ratio, which mainly depends on the flight speed and angle of attack [18], and is not sensitive to the altitude change, so the demand for pull at different altitudes is basically unchanged.

Using the model of Section 3, since the influence of the fuselage is not considered, the induced resistance is used to estimate the resistance of the whole aircraft. The induced resistance of the flight unit is calculated according to the following formula.

$$D_{i1} = \frac{1}{2} \rho_1 V_1^2 C_{Di1} S_1 \tag{16}$$

In the formula, the lower corner mark 1 represents the flight unit, and the induced resistance of the flight unit is calculated, $D_{i1}=14.91N$. The induced resistance of the small fixed wing UAV accounts for 25% ~ 40% of the total resistance. Here, the waste resistance of the flight unit is calculated according to the induced resistance accounting for 30% of the total resistance, $D_{p1}=41.74N$. Similarly, the induced resistance of the combination, D_{in} , can be obtained, while the waste resistance of the combination, D_{pn} , can be calculated using the following formula.

$$D_{pn} = n D_{p1} \frac{V_n^2}{V_1^2} \tag{17}$$

Then calculate the tensile demand of a single propeller through the following formula.

$$F_n = \frac{D_{in} + D_{pn}}{n} \tag{18}$$

The relationship between tensile force F_n and n is shown in Figure 8.

Table 2: Relationship between tensile force F_n and n

n	Tensile demand of single propeller F_n [N]
1	56.64
2	45.59
3	41.48
4	39.15
5	37.81
6	36.78
7	36.05

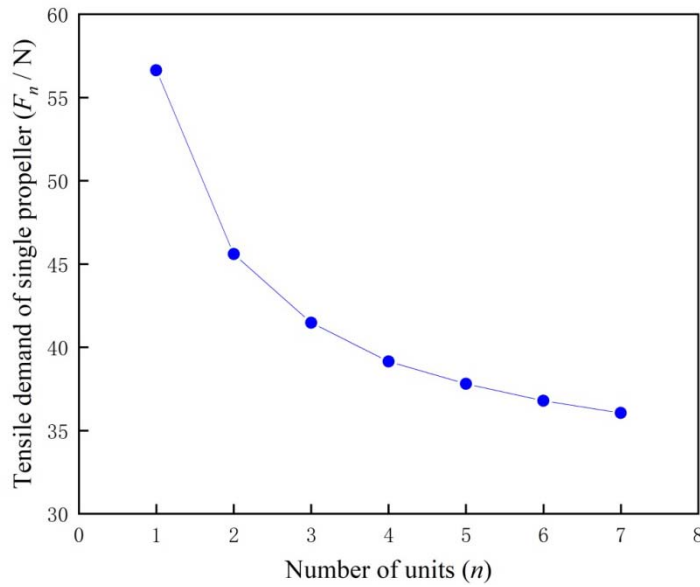

Figure 8: Relationship and trend between tensile force F_n and n

It can be seen that the required tension F_n decreases with the increase of n , and the change rate decreases.

b) *Wingtip Connection can Raise the Ceiling*

When estimating the resistance according to Section 4.1 using the model of section 3, for a motor

drive, the 1.5:1 reduction mechanism and 16×8 APC propeller is calculated under 32 V power supply. The maximum pull of single propeller at different altitudes is shown in Table 3, and Figure 9 is drawn accordingly.

Table 3: Maximum tension at different altitudes

Altitude H [km]	Maximum pulling force F_{max} [N]	Altitude H [km]	Maximum pulling force F_{max} [N]
0	60.22	7	46.30
1	58.61	8	43.61
2	56.91	9	40.65
3	55.10	10	37.43
4	53.15	11	33.83
5	51.05	12	29.84
6	48.76		



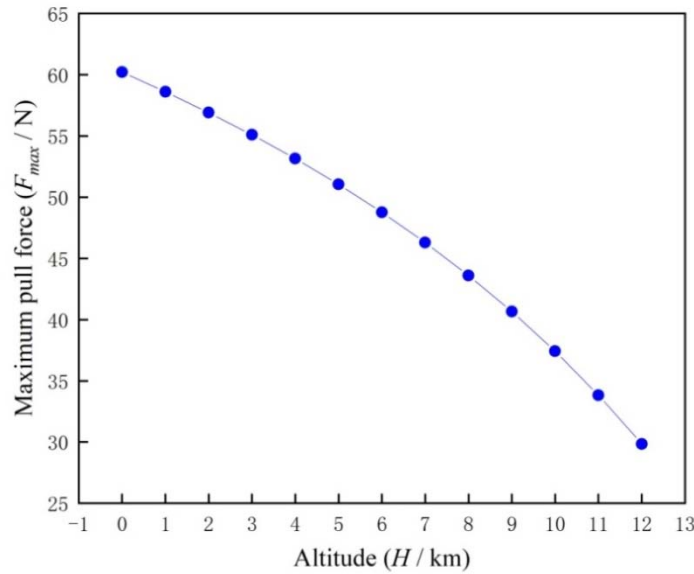

Figure 9: Relationship between altitude and maximum pulling force of single propeller

The fitting formula of the curve is obtained.

$$F_{\max} = -0.1037H^2 - 1.0283H + 61.071 \quad (19)$$

Substituting the values of F_n in Table 2 into the formula above, the obtained results are the different ceiling with different n , and the results are shown in Table 4.

Table 4: Ceiling of different unit number

n	Tensile demand of single propeller F_n [N]	Ceiling H_{\max} [km]
1	56.64	3.25
2	45.59	8.22
3	41.48	9.65
4	39.15	10.40
5	37.81	10.82
6	36.78	11.13
7	36.05	11.35

The relationship between n and the ceiling is shown in Figure 10.

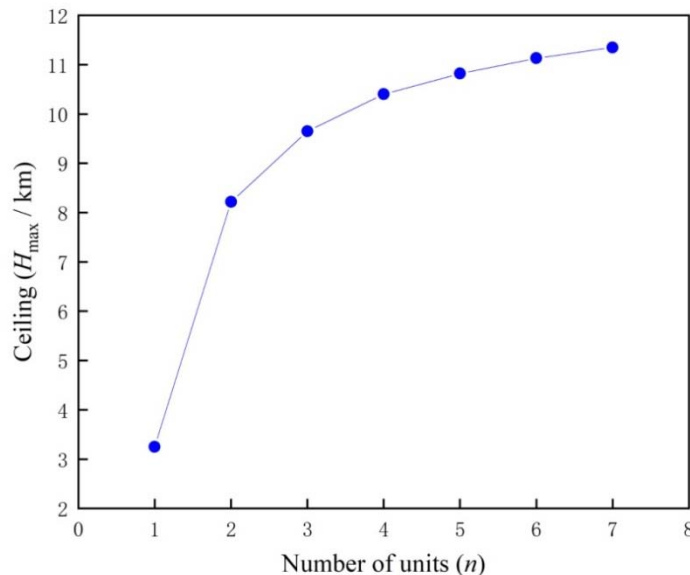

Figure 10: Relationship between n and the ceiling

It can be seen that increasing the number of flight units can effectively improve the ceiling of the aircraft. The ceiling increases with the increase of n , while the change rate decreases.

km, the working current and flight time of the combination with different n are calculated as shown in Table 5.

c) *Wingtip Connection can Increase Endurance Time*

Assuming a 128 Ah 32 V power supply is used and the combination flies horizontally at an altitude of 2

Table 5: Influence on working current and flight time 1n

n	Current [A]	Flight time [min]	Endurance improvement
1	29.93	256.6	0.00%
2	21.78	352.7	37.45%
3	18.97	404.8	57.76%
4	17.45	440.2	71.55%
5	16.59	463.0	80.44%
6	15.93	482.0	87.83%
7	15.48	496.2	93.37%

The relationship between n and flight time is shown in Figure 11.

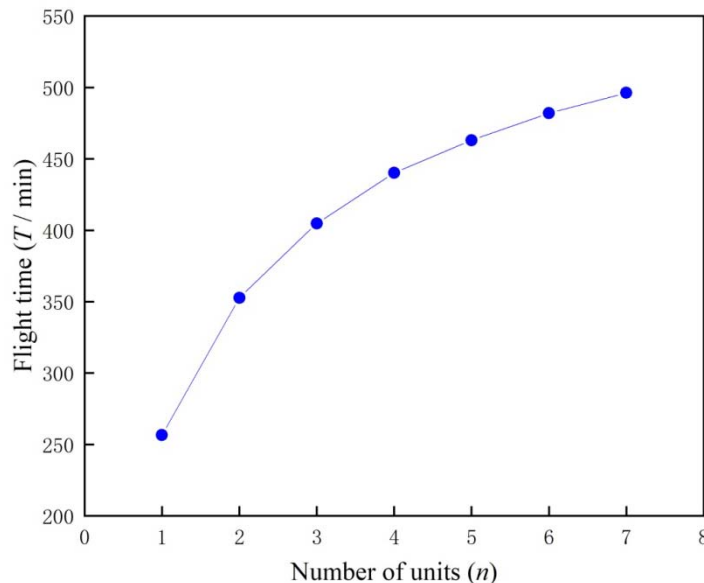

Figure 11: Relationship between n and flight time

It can be seen that increasing the number of flight units can effectively improve the flight time. The endurance time increases with the increase of n , while the change rate decreases.

V. RESULTS AND DISCUSSION CONCLUSION

With the rise of cluster UAVs, wingtip connection technology has been paid attention again. Wingtip connection can make the flight unit fly higher, farther and more durable.

Firstly, the theoretical analysis of wingtip connection is carried out, and two conclusions are obtained through the theoretical analysis. First, the lift-drag ratio of the combination K_n is proportional to $\sqrt{ne_n}$, and the Oswald efficiency factor e_n decreases with the

increase of n ; The second is that the cruise speed of the combination V_n is inversely proportional to $\sqrt{C_{Ln}}$. Then, the correctness of the above two conclusions is verified by simulation. Based on this, the influence of wingtip connection on endurance performance is analysed, and the following conclusions are obtained. First, the flight altitude has little effect on the tensile demand, but tensile demand decreases with the increase of n , while the change rate decreases; The second is that the ceiling increases with the increase of n , while the rate of change decreases; Third, the endurance time increases with the increase of n , while the change rate decreases. Theoretically, increasing the number of units n can continuously improve the flight performance of aircraft.

However, as the number of assembly units increases, the ceiling and endurance benefits brought by connection gradually decrease. In addition, large-scale wingtip connections have high requirements for control systems and connecting mechanisms. Too many units will lead to more complex control and connecting mechanisms with greater loads. Therefore, the number of wingtip connections is not the more the better.

Data Availability

The aerodynamic parameters in this paper are calculated by xflr5 v6.48, and the file has been uploaded. The file name is *model.xfl*.

Conflicts of Interest

The authors declare that there is no conflict of interest regarding the publication of this paper.

ACKNOWLEDGMENTS

The authors are grateful for the financial support from the China Aviation Science Foundation Program (201829U8007). They would also like to thank the Aeromodelling Team of RFUE for providing support.

REFERENCES RÉFÉRENCES REFERENCIAS

1. X. Wang, Z. Liu, Y. Cong, et al., "Miniature fixed wing UAV swarms: review and outlook," *Acta Aeronautica et Astronautica Sinica*, vol. 41, no. 4, pp. 20-45, 2020.
2. M. Wu, Z. Shi, T. Xiao, et al., "Effect of wingtip connection on the energy and flight endurance performance of solar aircraft," *Aerospace Science and Technology*, vol. 108, pp. 106404, 2021.
3. C. Anderson, "Dangerous experiments: wingtip coupling at 15,000 feet," *Flight Journal*, vol. 5, no. 6, pp. 64-72, 2000.
4. S. A. Magill, "Compound aircraft transport study: wingtip-docking compared to formation flight," *Virginia Polytechnic Institute and State University*, Blacksburg, Virginia, USA, 2002.
5. C. Montalvo, "Meta aircraft flight dynamics and controls," *Georgia Institute of Technology*, Atlanta, Georgia, US, 2014.
6. C. Montalvo, M. Costello, "Meta aircraft flight dynamics," *Journal of Aircraft*, vol. 52, no. 1, pp. 107-115, 2015.
7. C. Montalvo, M. Costello, "Meta aircraft connection dynamics," in *AIAA guidance, navigation, and control conference*. Minneapolis, Minnesota, USA, 2012.
8. C. Collin, C. Montalvo, "Experimental control of two connected fixed wing aircraft," *Aerospace*, vol. 113, no. 5, pp. 1-13, 2018.
9. M. Cobar, C. Montalvo, "Takeoff and Landing of a Wing-Tip-Connected Meta Aircraft with Feedback Control," *Journal of Aircraft*, vol. 58, no. 4, pp. 733-742, 2021.
10. J. R. Cooper, P. M. Rothhaar, "Dynamics and control of in-flight wing tip docking," *Journal of Guidance Control & Dynamics*, vol. 41, no. 11, pp. 2327-2337, 2018.
11. S. Wlach, G. Balmer, M. Hermann, et al., "ELAHA-elastic aircraft for high altitudes concept and current development state of an unconventional stratospheric UAV," in *23rd ESA Symposium on European Rocket and Balloon Programmes and Related Research*. Visby, Sweden, 2017.
12. A. Köthe, A. Behrens, A. Hamann, et al., "Closed-loop flight tests with an unmanned experimental multi-body aircraft," in *17th International Forum on Aeroelasticity and Structural Dynamics*. Como, Italy, 2017.
13. R. Zhou, W. Zhou, D. Wang, et al., "Overview of UAV link wing system technology," in *the 5th Joint Conference of Aerospace Propulsion (JCAP) Technical Conference*. Nanjing: 2020: 2336-2344.
14. Y. Yang, Z. Zhang, P. Ying, et al., "Flexible modular swarming UAV: innovative, opportunities, and technical challenges," *Flight Dynamics*, vol. 39, no. 2, pp. 1-9+15, 2021.
15. W. Zhou, P. Ma, Z. Guo, et al., "Research progress of combined fixed-wing unmanned aerial vehicle based on wingtip chained," *Acta Aeronautica et Astronautica Sinica*, vol. 43, no. 9, pp. 606-622, 2022.2022, 43(09): 606-622.
16. C. An, C. Xie, Y. Meng, et al., "Flight mechanical analysis and test of unmanned multi-body aircraft," in *International Forum on Aeroelasticity and Structural Dynamics*. Savannah, Georgia, USA, 2019.
17. T. Chen, J. Katz, "Induced drag of high-aspect ratio wings," in *42nd AIAA Aerospace Sciences Meeting and Exhibit*, Reno, Nevada, USA, 2004.
18. Z. Fang, W. Chen, S. Zhang, *Flight dynamics of aircraft*, Beihang University Press, Beijing, 2005.